

IC Recorder

Operating Instructions

ICD-SX700/SX800

IC RECORDER

© 2009 Sony Corporation

Getting Started.....	■
Recording.....	■
Playback.....	■
Editing Messages.....	■
Utilizing the Menu Function.....	■
Utilizing Your Computer.....	■
Troubleshooting.....	■
Additional Information.....	■
Index.....	■

For customers in Europe

Disposal of Old Electrical & Electronic Equipment (Applicable in the European Union and other European countries with separate collection systems)



This symbol on the product or on its packaging indicates that this product shall not be treated as household waste. Instead it shall be handed over to the applicable collection point for the recycling of electrical and electronic equipment. By ensuring this product is disposed of correctly, you will help prevent potential negative consequences for the environment and human health, which could otherwise be caused by inappropriate waste handling of this product. The recycling of materials will help to conserve natural resources. For more detailed information about recycling of this product, please contact your local Civic Office, your household waste disposal service or the shop where you purchased the product.

Applicable accessories: USB connecting cable, cradle

Disposal of waste batteries (applicable in the European Union and other European countries with separate collection systems)



This symbol on the battery or on the packaging indicates that the battery provided with this product shall not be treated as household waste. On certain batteries this symbol might

be used in combination with a chemical symbol. The chemical symbols for mercury (Hg) or lead (Pb) are added if the battery contains more than 0.0005% mercury or 0.004% lead.

By ensuring these batteries are disposed of correctly, you will help prevent potentially negative consequences for the environment and human health which could otherwise be caused by inappropriate waste handling of the battery. The recycling of the materials will help to conserve natural resources. In case of products that for safety, performance or data integrity reasons require a permanent connection with an incorporated battery, this battery should be replaced by qualified service staff only. To ensure that the battery will be treated properly, hand over the product at end-of-life to the applicable collection point for the recycling of electrical and electronic equipment.

For all other batteries, please view the section on how to remove the battery from the product safely. Hand the battery over to the applicable collection point for the recycling of waste batteries.

For more detailed information about recycling of this product or battery, please contact your local Civic Office, your household waste disposal service or the shop where you purchased the product.

Notice for the customers: the following information is only applicable to equipment sold in the countries applying EU directives

The manufacturer of this product is Sony Corporation, 1-7-1 Konan, Minato-ku, Tokyo, Japan. The Authorized Representative for EMC and product safety is Sony Deutschland GmbH, Hedelfinger Strasse 61, 70327 Stuttgart, Germany. For any service or guarantee matters please refer to the addresses given in separate service or guarantee documents.

- The recorded music is limited to private use only. Use of the music beyond this limit requires permission of the copyright holders.
- Sony is not responsible for incomplete recording/downloading or damaged data due to problems of the IC recorder or computer.
- Depending on the types of the text and characters, the text shown on the IC recorder may not be displayed properly on device. This is due to:
 - The capacity of the connected IC recorder.
 - The IC recorder is not functioning normally.
 - Content information is written in the language or the character that is not supported by the IC recorder.

Notice for users

Program © 1999, 2000, 2001, 2002, 2003, 2004, 2005, 2006, 2007, 2008, 2009 Sony Corporation
Documentation ©2009 Sony Corporation

All rights reserved. This manual or the software described herein, in whole or in part, may not be reproduced, translated or reduced to any machine readable form without prior written approval from Sony Corporation.

IN NO EVENT SHALL SONY CORPORATION BE LIABLE FOR ANY INCIDENTAL, CONSEQUENTIAL OR SPECIAL DAMAGES, WHETHER BASED ON TORT, CONTRACT, OR OTHERWISE, ARISING OUT OF OR IN CONNECTION WITH THIS MANUAL, THE SOFTWARE OR OTHER INFORMATION CONTAINED HEREIN OR THE USE THEREOF.

Sony Corporation reserves the right to make any modification to this manual or the information contained herein at any time without notice. The software described herein may also be governed by the terms of a separate user license agreement.

- This software is for Windows and cannot be used for Macintosh.
- The supplied connecting cable is for the IC recorder ICD-SX700/SX800. You cannot connect other IC recorders.

Table of Contents

Checking the Contents of the Package.....	7
Index to Parts and Controls.....	8

Getting Started

Step 1: Preparing a Power Source	14
Inserting the batteries.....	14
Disconnecting the IC recorder from your computer.....	15
When charging/replacing the batteries	16
Step 2: Setting the Clock.....	19
Continued directly from "Step 1: Preparing a Power Source".....	19
Setting the clock using the menu	20
Step 3: Setting the Language to Be Used in the Display Window	21
Step 4: Preparations Required before Recording	23
Turning the IC Recorder On or Off.....	25
Turning the power off.....	26
Turning the power on	26

Recording

Recording Messages.....	27
Selecting the Recording Mode.....	30
Setting the Recording Level	33
Manual Recording Mode.....	35
Setting the Input Level Automatically to Prevent Sound Distortion – the Limiter Function	37
Recording a Few Seconds in Advance, before Starting to Record – the Pre-Recording Function	38
Cutting out Low Frequency – the LCF Function.....	41
Starting to Record Automatically in Response to Sound – the VOR Function	42
Dividing a Message into Two During Recording	43
Adding a Recording to a Previously Recorded Message	45
Adding an Overwrite Recording during Playback.....	47
Recording with an External Microphone	49
Recording sound from a telephone or a cell phone	50

Recording from Other Equipment.....	50
To record using the synchronized recording function	51
To record without using the synchronized recording function	52

Playback

Playing Back Messages.....	54
Selecting the Playback Mode	57
Playing back a specified section repeatedly – A-B Repeat.....	58
Adjusting the Playback Speed – the DPC Function.....	59
Reinforcing the Bass Sound	60
Reducing Distortion to Make the Human Voice Clearer – the Noise Cut Function.....	61
Adjusting the Playback Sound by Amplifying Inaudible Sound – the Digital Voice Up Function.....	63
Adding a Bookmark	64
Recording with Other Equipment.....	66
Playing Back a Message at a Desired Time with an Alarm.....	67

Editing Messages

Erasing Messages.....	71
Erasing messages one by one	71
Erasing all messages in a folder	72
Moving a Message to a Different Folder.....	73
Dividing a Message into Two	75
Adding Priority Mark(s) – the Priority Mark Function	77
Preventing Accidental Operation – the HOLD function	78

Utilizing the Menu Function

Making Settings for the Menu.....	79
-----------------------------------	----

Utilizing Your Computer

What You Can Do Using the Computer	93
System requirements for your computer	94
Connecting the IC recorder to your computer	95
Disconnecting the IC recorder from your computer.....	96
Copying Files from the IC Recorder to Your Computer	96

Copying Files from Your Computer to the IC Recorder and Playing Them Back	97
Construction of folders and files	99
Using the Supplied Digital Voice Editor Software	101
What You Can Do Using the Digital Voice Editor Software	101
System requirements	103
Installing the software	104
Referring to the help files.....	108
Transferring the files using the Digital Voice Editor software.....	108
Using the IC Recorder as a USB Mass Storage Device.....	109

Precautions.....	127
Specifications.....	129
Index.....	131

Troubleshooting

Troubleshooting.....	110
IC recorder.....	110
Error messages	120
System limitations	123

Additional Information

Using a USB AC Adaptor (not supplied)	125
Disconnecting the IC recorder from the AC outlet.....	126

Checking the Contents of the Package

IC Recorder (1)

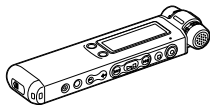

Remove the film on the display window before you use the IC recorder.

NH-AAA (size AAA) rechargeable batteries (2)



Stereo headphones* (1)



USB connecting cable (1)



Wind Screen (1)



Application Software, Digital Voice Editor (CD-ROM)

Cradle* (1)

Stand (1)

Carrying pouch (1)

Microphone* (1)

Battery case (1)

Operating Instructions

* The stereo headphones, the cradle and the microphone are supplied with some models in some regions only.

You are cautioned that any changes or modifications not expressly approved in this manual could void your authority to operate this equipment.

Index to Parts and Controls

Refer to the pages indicated in parentheses for details.

Front

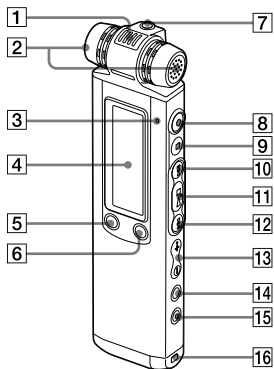

- 1** Built-in microphone (directional) (28, 36)
- 2** Built-in microphones (stereo) (28, 36)
- 3** Operation indicator (15, 18, 27, 54, 91)
- 4** Display window (10)
- 5** DIVIDE/✎ (bookmark) button (44, 65, 75)

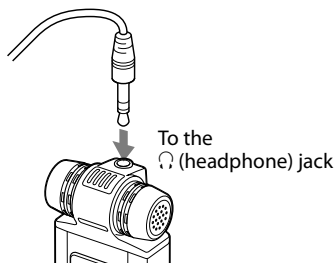

- 6** (folder)/MENU button (27, 54, 79)
- 7** (headphone) jack* (29, 55, 66)
- 8** (record/pause) button (27, 29, 40)
- 9** (stop) button (28, 54, 69, 79)
- 10** (cue/fast forward) button (27, 54, 55, 65, 79)
- 11** (play/stop/enter) button (29, 54, 56, 79)
- 12** (review/fast backward) button (27, 54, 55, 65, 79)
- 13** VOL (volume) +/- button (29, 54)
- 14** (repeat) A-B/★ (priority) button (58, 77)
- 15** ERASE button (71)
- 16** Opening for a handstrap
(A handstrap is not supplied.)

- * Connect the supplied or commercially available stereo headphones to the  (headphone) jack. If unwanted noise is heard, wipe the headphones plug clean.

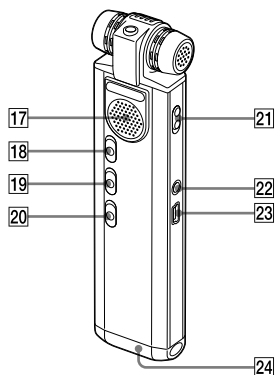

Rear



- 17** Speaker
- 18** HOLD switch (21, 26, 78)
- 19** NOISE CUT switch (61)
- 20** DPC switch (59)
- 21** DIRECTNL (directional) switch (29)
- 22**  (microphone) jack (49, 51)
- 23**  (USB) connector (14, 95, 125)
- 24** Battery compartment (14)

Display window

Display during playback and stop

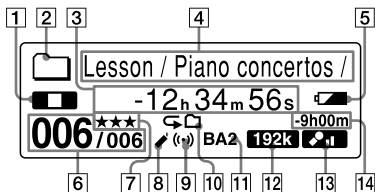

- 1** Operating mode indicator
Displays the following, depending on the current operation mode

⏸ : stop

▶ : playback

⏮ ⏭ : review (fast backward)/
cue (fast forward)

⏪ ⏩ : backward/forward
continuously

- 2** Folder indicator

📁 : Folder for messages recorded
using the IC recorder.

📁 : Folder for messages/music
copied from a computer, which
can only be played back.

- 3** Elapsed time/Remaining time/
Recorded date and time indication

- 4** Folder name/Message title/Artist
name/File name indication

- 5** Battery indicator

When rechargeable batteries or dry-cell batteries are used, the indicator shows the remaining battery power. While the rechargeable batteries are charging, an animation appears.

- 6** Message number

The selected message number is displayed in the numerator and the total number of messages in the folder is displayed in the denominator.

- 7** Priority marks



Appear(s) when a message is set with priority mark(s).

- 8** Bookmark indicator

Appears when a bookmark is set for a message.

- 9** Alarm indicator

Appears when the alarm is set for a message.





- 10** Repeat playback indicator
-  **1**: Appears when one message is played back repeatedly.
 - : Appears when messages in one folder are played back repeatedly.
 -  **ALL**: Appears when all the messages are played back repeatedly.
- 11** Sound effect indicator
- Displays the "EFFECT" setting in the menu.
- BA1**: "BASS1" has been selected. The bass sound is reinforced.
 - BA2**: "BASS2" has been selected. The bass sound is further reinforced.
- 12** Recording mode indicator
- Displays the recording mode set using the menu when the IC recorder is in the stop mode, and displays the current recording mode when the IC recorder is in the playback mode.
- 48k**, **128k**, **192k**: MP3 files recorded using the IC recorder
 - 2216**, **4416**: LPCM files recorded using the IC recorder
 - LP**, **SP**, **STLP**, **ST**, **STHQ**: LPEC files recorded using the IC recorder.

For details, see "Selecting the Recording Mode" (page 30).
Displays one of the following when a file is transferred from the computer.

- MP3**: MP3 files transferred
- LPCM**: LPCM files transferred
- WMA**: WMA files transferred

Displays the following icon if the IC recorder cannot recognize the file.



- 13** Recording level indicator
- Displays the currently selected microphone sensitivity for recording.
- : Recorded with the low recording level.
 - : Recorded with the high recording level.
 - : Recorded with the further high recording level.
 - : Recorded with proper balance for music.
 - MAN**: Recorded with the manual recording mode.

14 Remaining recording time indication

Displays the remaining recording time in hours, minutes, and seconds. If there is more than 10 hours time remaining, the time is displayed in hours.

If there is more than 10 minutes and less than 10 hours time remaining, the time is displayed in hours and minutes.

If there is less than 10 minutes time remaining, the time is displayed in minutes and seconds.

Display during recording

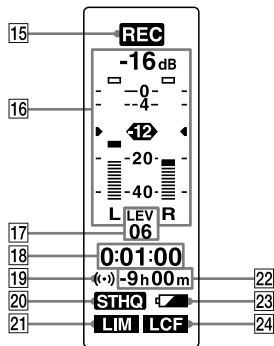

15 Operating mode indicator

Displays the following, depending on the current operation of the IC recorder.

REC : recording

● II : Flashes while recording
standby/recording pause

REC VOR : recording with the VOR
function

● II VOR : recording pause with the
VOR function (flashing)

If you press ● (record/pause) to pause recording when “VOR” is set to “ON” in the menu, only “●||” flashes.

REC SYNC : Synchronized recording

●|| SYNC : Flashes while synchronized recording is set to pause.

16 Recording level meter

17 Recording level indicator

Displays the current microphone sensitivity when recording.

🔊 : To record for dictation or in a noisy place.

🔊 : To record at a meeting or in a quiet/spacious place.

🔊 : To record with further high sensitivity.

🎵 : To record music.

Displays the recording level during manual recording.

18 Elapsed recording time/Pre-recording standby time indication

If more than 100 hours have elapsed since start of the recording, the time is displayed in hours and minutes.

If less than 100 hours have elapsed since start of the recording, the time is displayed in hours, minutes and seconds.

When “PRE REC” is set to “ON” in the menu, the pre-recording standby time is displayed in seconds between 0 and 5.

19 Alarm indicator

20 Recoding mode indicator

Displays the recording mode set in the menu.

21 Limiter indicator

LIM : When “LIMITER” is set to “ON” in the menu.

--- : When you are recording in other than the manual recording mode.

22 Remaining recording time indication

23 Battery indicator

24 LCF (Low Cut Filter) indicator

LCF : When “LCF (LOW CUT)” is set to “ON” in the menu.

--- : When “LCF (LOW CUT)” is set to “OFF” in the menu.

Step 1: Preparing a Power Source

Remove the film on the display window before you use the IC recorder.

Inserting the batteries

- 1 Slide and lift the battery compartment lid.

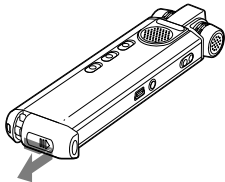

- 2 Insert two NH-AAA rechargeable batteries with correct polarity, and close the lid.

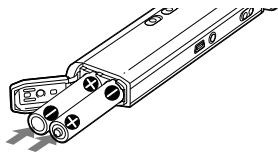

- 3 Charge the batteries by connecting the  (USB) connector of the IC recorder to your computer.

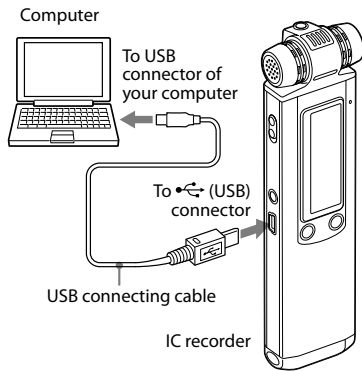

While the batteries are charging, "CONNECTING" and the battery indicator are displayed in an animation.

When the battery indicator indicates "" charging is completed. (Charging time: approx. 4 hours*)

When you use the IC recorder for the first time, or after you have not used the IC recorder for a certain period of time, it is recommended that you charge the batteries continuously until “Full” is displayed.

If the battery indicator is not displayed, charging has not been done properly. Proceed from step 1 again.

* This is an approximation for the time it takes to charge from no remaining battery power to full battery power at room temperature. It varies depending on the remaining power and the condition of the batteries. It also takes more time if the temperature of the batteries are low, or if the batteries are charged while you are transferring data to the IC recorder.

Disconnecting the IC recorder from your computer

Follow the procedures below; otherwise, data may be damaged.

- 1 Make sure that the operation indicator is not flashing.**
- 2 Disconnect the USB connecting cable connected to the IC recorder from the USB connector of the computer.**

On the Windows screen, left-click “Safely Remove Hardware” on the taskbar, and click “Safely remove USB Mass Storage Device.”

On the Macintosh screen, drag the “IC RECORDER” on the desktop to “Trash” and drop it there.

For details on disconnecting the IC recorder, refer to the operating instructions supplied with your computer.

Tips

- You can charge the rechargeable batteries by connecting the IC recorder to an AC outlet using a USB AC adaptor (not supplied) (page 125).
- When replacing the batteries, messages recorded or alarm settings are not erased even when you remove the batteries.
- When replacing the batteries, the clock continues moving for a certain period of time after you remove the batteries.

Notes

- While “**COLD**” or “**HOT**” is flashing instead of the battery indicator, you cannot charge the batteries. Charge the batteries in an environment with a temperature of 5 °C - 35 °C.
- If “USB CHARGE” in the “DETAIL MENU” menu is set to “OFF,” you cannot charge the batteries using your computer. Set “USB CHARGE” to “ON” (page 92).
- During playback using the internal speaker, you cannot charge the batteries.
- When you use the IC recorder with rechargeable batteries, the battery indicator may not light fully.

Clock setting display appears and the year section flashes when you insert batteries for the first time, or when you insert batteries after the IC recorder has been without batteries for a certain period of time. Please refer to “Continued directly from “Step 1: Preparing a Power Source”” on page 19 to set the date and time.

When charging/replacing the batteries

The battery indicator on the display shows the battery condition.

Battery remain indication

 : Charge the rechargeable batteries or replace the old batteries with new ones.

↓
 : “LOW BATTERY” appears and the IC recorder will stop operation.

You can use commercially available LR03 (size AAA) alkaline batteries, however you cannot use manganese batteries.

Battery life*1

When using Sony NH-AAA rechargeable batteries

	Recording	Playback ^{*2} through speaker	Playback using the headphones
LPCM 44/16 ^{*3}	Approx. 19 hr.	Approx. 16 hr.	Approx. 20 hr.
LPCM 22/16 ^{*4}	Approx. 17 hr.	Approx. 15 hr.	Approx. 18 hr.
MP3 192k ^{*5}	Approx. 17 hr.	Approx. 16 hr.	Approx. 20 hr.
MP3 128k ^{*6}	Approx. 17 hr.	Approx. 16 hr.	Approx. 20 hr.
MP3 48k ^{*7}	Approx. 19 hr.	Approx. 16 hr.	Approx. 20 hr.
LPEC STHQ ^{*8}	Approx. 14 hr.	Approx. 15 hr.	Approx. 18 hr.
LPEC ST ^{*9}	Approx. 15 hr.	Approx. 16 hr.	Approx. 19 hr.
LPEC STLP ^{*10}	Approx. 17 hr.	Approx. 16 hr.	Approx. 20 hr.
LPEC SP ^{*11}	Approx. 17 hr.	Approx. 17 hr.	Approx. 21 hr.
LPEC LP ^{*12}	Approx. 19 hr.	Approx. 18 hr.	Approx. 22 hr.
Music file (WMA 128 kbps/ 44.1 kHz)	—	Approx. 16 hr.	Approx. 19 hr.

(hr. : hours)

When using Sony LR03 (SG) (size AAA) alkaline batteries

	Recording	Playback ^{*2} through speaker	Playback using the headphones
LPCM 44/16 ^{*3}	Approx. 25 hr.	Approx. 21 hr.	Approx. 26 hr.
LPCM 22/16 ^{*4}	Approx. 23 hr.	Approx. 19 hr.	Approx. 23 hr.
MP3 192k ^{*5}	Approx. 22 hr.	Approx. 21 hr.	Approx. 26 hr.
MP3 128k ^{*6}	Approx. 22 hr.	Approx. 21 hr.	Approx. 26 hr.
MP3 48k ^{*7}	Approx. 25 hr.	Approx. 21 hr.	Approx. 26 hr.
LPEC STHQ ^{*8}	Approx. 18 hr.	Approx. 20 hr.	Approx. 24 hr.
LPEC ST ^{*9}	Approx. 20 hr.	Approx. 21 hr.	Approx. 25 hr.
LPEC STLP ^{*10}	Approx. 22 hr.	Approx. 21 hr.	Approx. 27 hr.
LPEC SP ^{*11}	Approx. 22 hr.	Approx. 22 hr.	Approx. 28 hr.
LPEC LP ^{*12}	Approx. 26 hr.	Approx. 24 hr.	Approx. 30 hr.
Music file (WMA 128 kbps/ 44.1 kHz)	—	Approx. 20 hr.	Approx. 25 hr.

(hr. : hours)

- ^{*1} The battery life may shorten depending on how you operate the IC recorder.
- ^{*2} When playing back music through the internal speaker with the volume level set to 20
- ^{*3} LPCM 44/16: LPCM file recorded using the IC recorder in stereo high-quality recording mode
- ^{*4} LPCM 22/16: LPCM file recorded using the IC recorder in stereo long play recording mode
- ^{*5} MP3 192k: MP3 file recorded using the IC recorder in stereo high-quality recording mode
- ^{*6} MP3 128k: MP3 file recorded using the IC recorder in stereo standard recording mode
- ^{*7} MP3 48k: MP3 file recorded using the IC recorder in monaural standard recording mode
- ^{*8} LPEC STHQ: LPEC stereo high quality recording mode
- ^{*9} LPEC ST: LPEC stereo standard recording mode
- ^{*10} LPEC STLP: LPEC stereo long play recording mode
- ^{*11} LPEC SP: LPEC monaural standard play recording mode
- ^{*12} LPEC LP: LPEC monaural long play recording mode

Note while accessing

The IC recorder is accessing data when an updating animation and “UPDATING DATABASE...” appear in the display window or the operation indicator flashes in orange. While the IC recorder is accessing data, do not remove the batteries or connect or disconnect the USB AC adaptor (not supplied). Doing so may damage the data.

Note

If the IC recorder is required to process a large amount of data, an updating animation and “UPDATING DATABASE...” may be displayed for an extended period of time. This is not a malfunction of the IC recorder. Wait until the animation and message disappear before starting operation.

Step 2: Setting the Clock

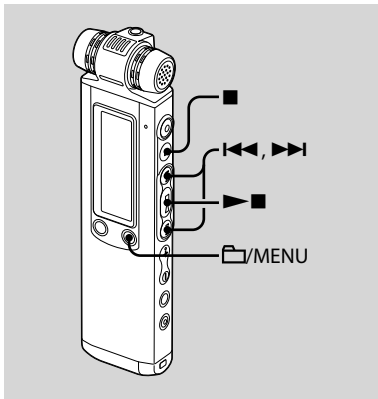

You need to set the clock to use the alarm function or record the date and time.

Clock setting display appears when you insert batteries for the first time, or when you insert batteries after the IC recorder has been without batteries for a certain period of time, "SET DATE & TIME" appears, and then the year section flashes in the display window.

Continued directly from "Step 1: Preparing a Power Source"

- 1 Press ◀◀ or ▶▶ to set the year, month, day, hour, and minute in sequence, then press ▶■.

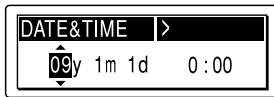

"EXECUTING..." appears and the clock is set.

- 2 Press ■ (stop) to return to the display of the stop mode.

Setting the clock using the menu

While the IC recorder is in the stop mode, you can set the clock using the menu.

1 Select "DATE & TIME" in the menu.

- 1 Press and hold /MENU to enter the menu mode.
The menu mode window will be displayed.



- 2 Press **◀◀** or **▶▶** to select "DETAIL MENU," then press **▶■**.
- 3 Press **◀◀** or **▶▶** to select "DATE & TIME," then press **▶■**.



- 2 Press **◀◀** or **▶▶** to select "AUTO" or "MANUAL" and press **▶■**.

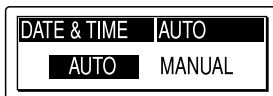

When you selected "AUTO," the clock is automatically adjusted using the clock in the computer connected to the IC recorder and on which the supplied Digital Voice Editor software is started. When you select "MANUAL," proceed to the next steps.

- 3 Press the **◀◀** or **▶▶** to select "09y1m1d," then press **▶■**.

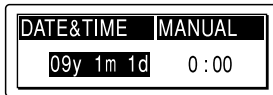

- 4 Press **◀◀** or **▶▶** to set the year, month, day, hour, and minute in sequence, then press **▶■**.

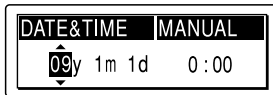

"EXECUTING..." appears and the clock is set.

5 Press **■** (stop) to return to the display of the stop mode.

Tips

- Press **☰**/MENU to return to the previous operation.
- You can set the time display for the clock to "12-HOUR" or "24-HOUR" in the menu. When "12-HOUR" is set, "AM" or "PM" appears in the display window.

Note

If you do not press **▶** **■** within one minute of entering the clock setting data, the clock setting mode is cancelled and the window will return to the display of the stop mode.

To display the current time

Slide the HOLD switch in the direction of the arrow to display the current time.

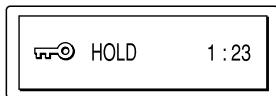



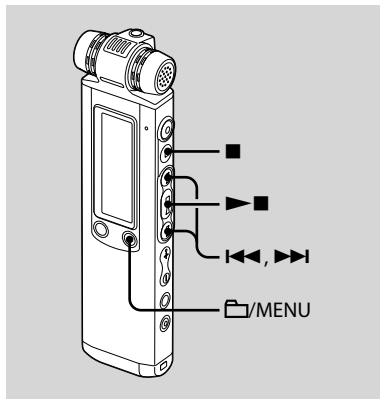

Step 3: Setting the Language to Be Used in the Display Window







You can select the language to be used for messages, menus, folder names, file names, etc. from 2 languages (European model)/7 languages (other models).

1 Press and hold /MENU to enter the menu mode.

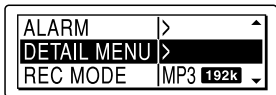



The menu mode window will be displayed.

2 Press  or  to select "DETAIL MENU," then press  .

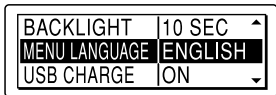

3 Press  or  to select "MENU LANGUAGE," then press  .



4 Press  or  to select the language that you want to use, then press  .

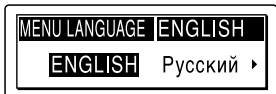

You can select the following languages.

European model :

ENGLISH, Русский (Russian)

Other models :

ENGLISH, Русский (Russian),

日本語 (Japanese), 한국어 (Korean),

简体中文 (Chinese), 繁體中文 (Chinese),

ไทย (Thai)

5 Press  (stop) to exit the menu mode.

Step 4: Preparations Required before Recording

Recording at a meeting

- Set “REC LEVEL” to “HIGH” or “S-HIGH” in the menu (page 33).
- Slide the DIRECTNL switch to “ON” to record a voice coming from a specific direction (page 29).
- Set “LCF (LOW CUT)” to “ON” in the menu to prevent noise caused by a projector, etc. (page 41).
- By placing the IC recorder on the stand, you can record with clear and low-noise sound, without vibration noise from the desk.

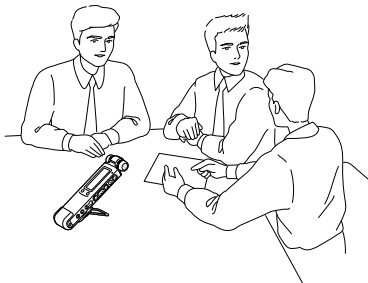

Recording a musical performance

- Set “REC LEVEL” to “MUSIC” in the menu to record more natural acoustic sound, with preventing sound distortion. For more realistic sound recording, you can adjust the recording level manually by setting “REC LEVEL” to “MANUAL” (page 35).
- Set “LIMITER” to “ON” in the menu (page 37), to prevent distortion when a loud sound is suddenly input.
- By attaching a tripod (not supplied) using the stand, you can adjust the angles of the IC recorder and the built-in microphones more precisely.

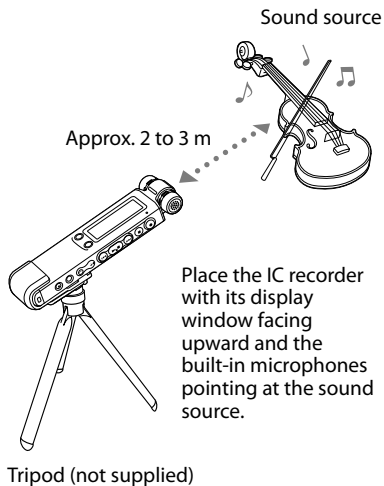

Recording dictation (using the voice recognition software)

- Set "REC LEVEL" to "LOW"  in the menu (page 33).
- Slide the DIRECTNL switch to "ON" to record a voice coming from a specific direction (page 29).
- To transcribe a message recorded on the IC recorder using voice recognition software (not supplied), set "REC MODE" to the LPCM, MP3 or LPEC (except LP) mode (page 30).



- Before you can transcribe recorded messages, you have to create a user file specifically adapted to the sound of your recorded speech. This procedure is called "training." For details on "training," refer to the help files supplied with the voice recognition software you are using.

- To obtain maximum recognition accuracy, hold the IC recorder so that the microphone is about 2 - 3cm from the corner of your mouth.
- To minimize the sound of your breath in the recordings, do not hold the microphone directly in front of your mouth.
- To obtain maximum recognition accuracy, avoid recording in a noisy place.
- You cannot transcribe a message recording the voices of more than one person.

Turning the IC Recorder On or Off

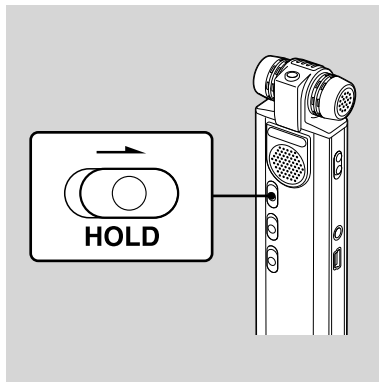

When you are not using the IC recorder, you can prevent the batteries from getting weak quickly by turning the power off.

Turning the power off

Slide the HOLD switch in the direction of the arrow in the stop mode. "HOLD" with the key mark and the current time is displayed, then "POWER OFF" is displayed. The IC recorder turns off within a few seconds.

Turning the power on

Slide the HOLD switch in the opposite direction from that of the arrow. The IC recorder turns on, and an accessing animation is displayed.

Tips

- When you are not going to use the IC recorder for a long time, we recommend to turn off the IC recorder.
- When about 10 minutes have passed after you have turned on the IC recorder and left it without doing anything, the display goes off automatically. (Press any button to show the display.)

Recording Messages

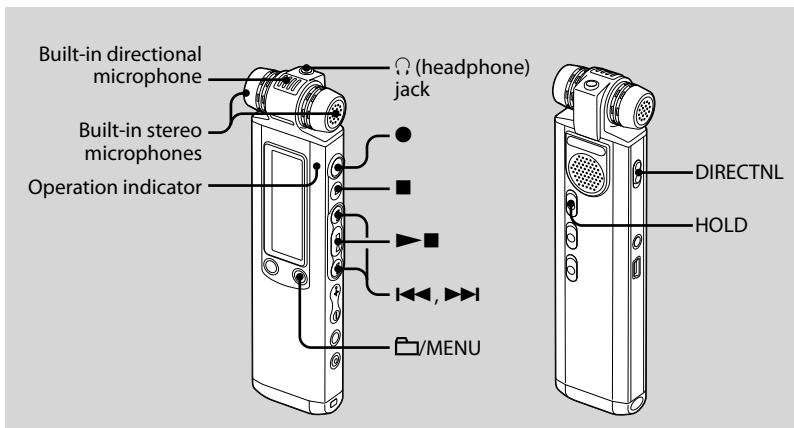

1 Select a folder.

- 1 Press 📁/MENU to display the folder selection window.
- 2 Press ◀◀ or ▶▶ to select the folder in which you want to record messages, then press ▶■.

2 Start recording.

- 1 Press ● (record/pause) in the stop mode.
The operation indicator lights in red. (When "LED" is set to "OFF" in the menu (page 91), the operation indicator does not light.)
You do not need to press and hold ● (record/pause) while recording.

The new message will be automatically recorded after the last recorded message.

- ② Speak into the built-in microphones.









3 Press (stop) to stop recording.

The IC recorder stops at the beginning of the current recording.

Tips

- Before you start recording, we recommend you make a trial recording first.
- When you purchase the IC recorder, there are 5 folders already available, and you can record up to 999 messages in each folder.
- You can make new folders or delete unwanted folders using the supplied Digital Voice Editor software (page 101).
- While recording, you can lock all the functions of all the buttons so that you can prevent inadvertent operations, by sliding the HOLD switch in the direction of the arrow.

Notes

- You cannot record a message in a  folder transferred from a computer. If you press  (record/pause) when you have selected a  folder, the folder will be automatically switched to a  folder in which a message can be recorded, and the message will be recorded as the last one in the folder.
- While the operation indicator is flashing or is lit in red or orange, do not remove the batteries or connect or disconnect the USB AC adaptor. Doing so may damage the data.
- Noise may be recorded if an object, such as your finger, etc., accidentally rubs or scratches the IC recorder during recording.
- Before making a recording, be sure to check the remaining power of the batteries (page 16).
- When "REC LEVEL" is set to "LOW " "HIGH " "S-HIGH " or "MUSIC ", the limiter function does not work.
- To avoid replacing batteries during a long recording session, use a USB AC adaptor (not supplied) (page 125).
- The maximum recording time varies if you record messages in different recording modes.

To	Do this
pause recording*	Press ● (record/pause). During recording pause, the operation indicator flashes in red and ● flashes in the display window.
release pause and resume recording	Press ● (record/pause) again. Recording resumes from that point. (To stop recording after pausing recording, press ■ (stop).)
review the current recording instantly**	Press ►■. Recording stops and playback starts from the beginning of the message just recorded.
review during recording**	Press and hold ◀◀ during recording or recording pause. Recording stops and you can search backwards while listening to fast playback sound. After you release ◀◀, playback starts from that point.

* One hour after you pause recording, recording pause is automatically released and the IC recorder enters the stop mode.

** You cannot select this function in the manual recording mode.

Monitoring the recording

Connect the supplied stereo headphones to the ◡ (headphone) jack and monitor the recording. You can adjust the monitoring volume by pressing VOL + or -, but the recording level is fixed.

Recording a sound centering on a specific direction

To record a sound centering on a specific direction, slide the DIRECTNL switch to the "ON" position. This is convenient when you want to record a particular sound at a conference/meeting, etc. When the DIRECTNL switch is set to "ON," the directional microphone is used, therefore the sound is recorded in the monaural mode even when you select the stereo recording mode (LPCM 44/16, LPCM 22/16, MP3 192k, MP3 128k, LPEC STHQ, LPEC ST or LPEC STLP mode). When you are using an external microphone, the DIRECTNL switch does not function.

When the DIRECTNL switch is set to "OFF"

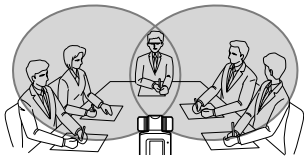

When the DIRECTNL switch is set to "ON"

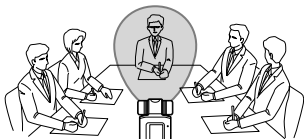

Selecting the Recording Mode

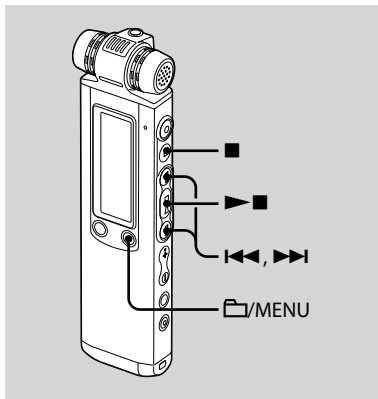

The IC recorder is compatible with 3 kinds of codec, LPCM (Linear PCM), MP3, and LPEC. The features offered by each are as follows.

LPCM (Linear PCM): This is a WAV file and you can record the sound without compression, providing higher quality than MP3 or LPEC. On the other hand, the file size is very large, it takes time to transfer to a computer, and the available recording time is shorter than either MP3

or LPEC. We recommend this codec for recording only when the sound quality is important, such as when recording a musical performance.

MP3: A standard method of sound compression, which can be played back using many different kinds of computers. We recommend this codec when you want to send recorded messages by mail or share them with other people.

LPEC: A sound compression method provided solely by Sony. You can play back, edit, and convert files to an MP3 or WAV format using the supplied application software, "Digital Voice Editor" We recommend you use this software when you want to edit messages/music recorded using the IC recorder on a computer. When you record messages using the LPEC format, you can add bookmarks and/or priority marks to the messages.

You can select the recording mode in the menu when the IC recorder is stopped. "REC MODE" is set to "MP3 192k" when you purchase the IC recorder.

1 Press and hold /MENU to enter the menu mode.

The menu mode window will be displayed.

2 Press or to select "REC MODE," then press .

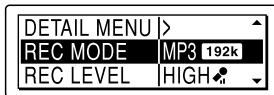

3 Press or to select the recording mode you want, then press .

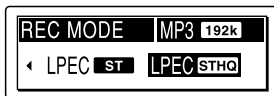

LPCM 44/16 : Stereo (44.1 kHz/16 bit/WAV)

You can record with stereo high-quality sound equivalent to a CD.

LPCM 22/16 : Stereo (22.05 kHz/16 bit/WAV)

You can record for a longer time with high-quality stereo sound.

MP3 192k : Stereo (44.1 kHz/192 kbps, MPEG1 Layer3)

You can record with high-quality stereo sound.

MP3 128k : Stereo (44.1 kHz/128 kbps, MPEG1 Layer3)

You can record with stereo sound.

MP3 48k : Monaural (44.1 kHz/48 kbps, MPEG1 Layer3)

You can record with monaural sound.

LPEC STHQ : Stereo (44.1 kHz/128 kbps)

You can record with high-quality stereo sound.

LPEC ST : Stereo (44.1 kHz/48 kbps)

You can record with standard stereo sound.

LPEC STLP : Stereo (44.1 kHz/24 kbps)

You can record for a longer time with stereo sound.

LPEC SP : Monaural (16 kHz/16 kbps)

You can record with standard monaural sound.

LPEC LP : Monaural (8 kHz/6 kbps)

You can record for a longer time with monaural sound.

4 Press **■** (stop) to exit the menu mode.

■ Note

You cannot set the recording mode while recording.

Maximum recording time

When all messages are recorded with the same recording mode, the maximum recording time of all the folders is as follows.

ICD-SX700

LPCM 44/16 mode	LPCM 22/16 mode	MP3 192k mode
1 hr. 30 min.	3 hr. 10 min.	11 hr. 40 min.
MP3 128k mode	MP3 48k mode	LPEC STHQ mode
17 hr. 35 min.	46 hr. 55 min.	17 hr. 20 min.
LPEC ST mode	LPEC STLP mode	LPEC SP mode
45 hr. 45 min.	88 hr. 10 min.	139 hr. 35 min.
LPEC LP mode		
372 hr. 25 min.		

ICD-SX800

LPCM 44/16 mode	LPCM 22/16 mode	MP3 192k mode
3 hr. 10 min.	6 hr. 25 min.	23 hr. 35 min.

MP3 128k mode	MP3 48k mode	LPEC STHQ mode
35 hr. 25 min.	94 hr. 40 min.	34 hr. 55 min.

LPEC ST mode	LPEC STLP mode	LPEC SP mode
92 hr. 15 min.	177 hr. 40 min.	281 hr. 20 min.

LPEC LP mode
750 hr. 15 min.

(hr. : hours/min. : minutes)

Setting the Recording Level

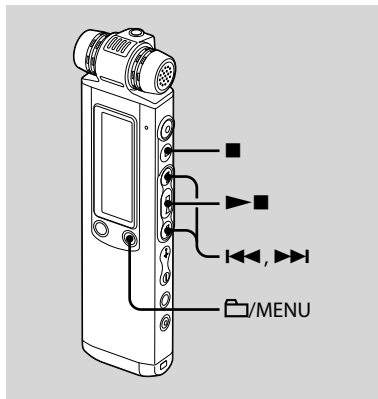

You can set the recording level in the menu when the IC recorder is stopped or is recording.





"REC LEVEL" is set to "HIGH " when you purchase the IC recorder.

1 Press and hold /MENU to enter the menu mode.

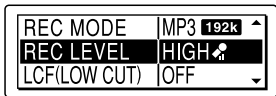
The menu mode window will be displayed.

2 Press  or  to select “REC LEVEL,” then press  .





3 Press  or  to select recording level you want, then press  .



LOW  : To record dictation with a microphone in front of your mouth, a sound near the IC recorder, or a loud sound.

HIGH  : To record the sound of a normal conversation or meeting, such as a recording made in a conference room or during interviews.

S-HIGH  : To record a sound far away from the IC recorder or a low sound, such as a recording made in a spacious room.

MUSIC  : To record more natural acoustic sound, as well as preventing sound distortion.

MANUAL : During manual recording, you can adjust the recording level manually.

4 Press  (stop) to exit the menu mode.

Manual Recording Mode

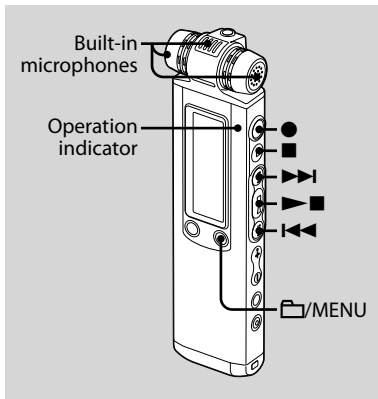

When you set "REC LEVEL" to "MANUAL," you can adjust the recording level manually.

1 Set "REC LEVEL" to "MANUAL" in the menu.

For details, see "Setting the Recording Level" (page 33).

2 Select a folder.

- 1 Press /MENU to display the folder selection window.
- 2 Press or to select the folder in which you want to record messages, then press .

3 Press and hold (record/pause).

The IC recorder enters the record standby mode. When you speak into the microphone, the level meter in the display window moves.

4 Press or to adjust the recording level, depending on the sound source.

Adjust the maximum level of the sound to be recorded to about -12 dB on the level meter, according to the sound source.

If "**OVER**" is displayed, press or and adjust the recording level down so that "**OVER**" is not displayed, to prevent sound distortion.

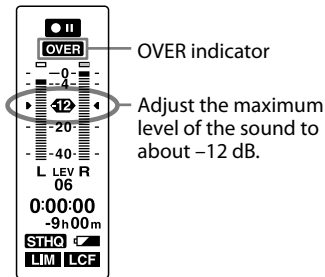

OVER indicator

Adjust the maximum level of the sound to about -12 dB.

Press and hold **◀◀** or **▶▶** to change the sound level continuously. The sound level is also displayed as a number below the level meter.

5 Make other settings for recording such as “LIMITER,” “LCF (LOW CUT),” etc., in the menu.

6 Start recording.

- ① Press **●** (record/pause).
The operation indicator lights in red and **REC** is displayed.
You do not need to press and hold **●** (record/pause) while recording.
- ② Speak into the built-in microphone.

7 Press **■** (stop) to stop recording.

Tip

The settings you have set for the manual recording mode are saved after the recording is finished or the recording level is switched to settings other than “MANUAL,” such as “LOW ”. You can start the manual recording with the same settings the next time.

Notes

- In the manual recording mode, you cannot record with the VOR function (page 42).
- In the manual recording mode, you cannot review the current recording, even if you press **▶■**.

Setting the Input Level Automatically to Prevent Sound Distortion – the Limiter Function

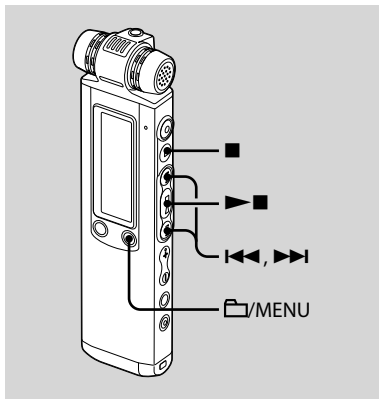

During the stop or recording mode set "LIMITER" to "ON," and the input level is set automatically within the maximum input level to prevent the sound distortion which occurs when a sound that is too loud is input. A sound that is too loud

is adjusted automatically to the proper level to prevent sound distortion. "LIMITER" is set to "ON" when you purchase the IC recorder.

- 1 Press and hold /MENU to enter the menu mode.

The menu mode window will be displayed.

- 2 Press or to select "DETAIL MENU," then press .

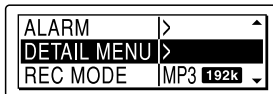

- 3 Press or to select "LIMITER," then press .

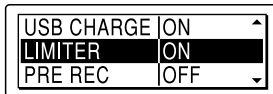

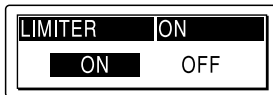

- 4 Press or to select "ON," then press .



5 Press ■ (stop) to exit the menu mode.

Note

When "REC LEVEL" is set to "LOW" , "HIGH" , "S-HIGH" , or "MUSIC" , the limiter function does not work.

To cancel the limiter function

Set "LIMTER" to "OFF" in step 4.

Recording a Few Seconds in Advance, before Starting to Record – the Pre-Recording Function

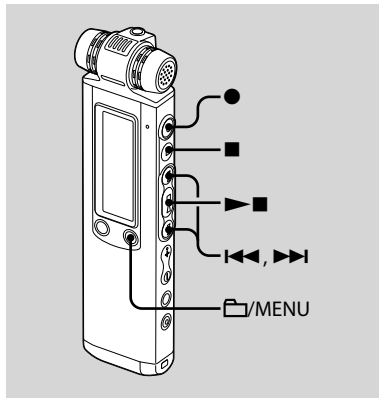

The pre-recording function allows you to record sound sources for a maximum of 5 seconds prior to the point when the recording is started. Sounds for 5 seconds are buffered in the memory.

This is useful to record during interviews or when making an open-air recording so that you will not miss the chance to start recording.

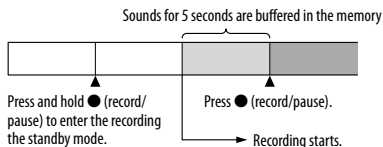

1 Press and hold /MENU to enter the menu mode.

The menu mode window will be displayed.

2 Press or to select “DETAIL MENU,” then press .

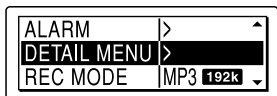

3 Press or to select “PRE REC,” then press .

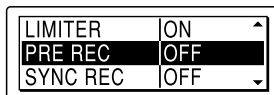

4 Press or to select “ON,” then press .

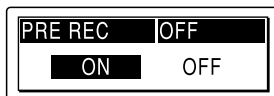

5 Press (stop) to exit the menu mode.

6 Select a folder.

- ① Press /MENU to display the folder selection window.
- ② Press or to select the folder in which you want to record messages, then press .

7 Press and hold ● (record/pause) to enter the recording standby mode.

Sounds for the last 0 to 5 seconds are buffered in the memory.

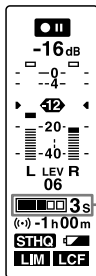

Displays that the sound for 0 to 5 seconds are buffered in the memory.

8 Press ● (record/pause) to start recording.

The standby for recording mode is released, and recording starts. Sounds are saved for the 0 to 5 seconds prior to the point the button is pressed.

9 Press ■ (stop) to stop recording.

Notes

- If you start recording with pre-recording function using the built-in microphones, a click noise may be recorded when you press ● (record/pause). To record with pre-recording function, we recommend using an external microphone.
- When the remaining recordable time is less than 10 seconds, the pre-recording function is disabled.
- When 60 minutes have passed after the IC recorder entered the standby mode, the standby mode will be cancelled and recording stops.
- If you stop recording before step 8, sounds buffered in the memory will not be saved.

To cancel the pre-recording function

Set "PRE REC" to "OFF" in step 4.

Cutting out Low Frequency – the LCF Function

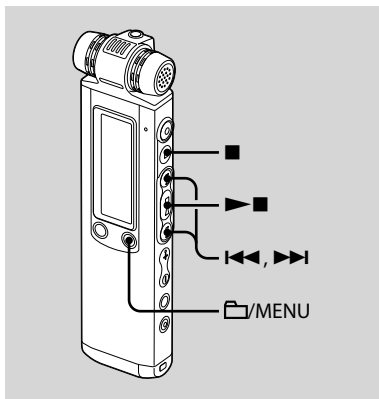

When you set the LCF (Low Cut Filter) function to "ON" in the stop or recording mode, you cut out a frequency of lower than 200 Hz to reduce the roaring noise from wind, etc., this helps to record a sound source more clearly. The LCF function is set to "OFF" when you purchase the IC recorder.

- 1 Press and hold /MENU to enter the menu mode.

The menu mode window will be displayed.

- 2 Press or to select "LCF (LOW CUT)," then press .

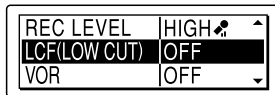

- 3 Press or to select "ON," then press .



- 4 Press (stop) to exit the menu mode.

To cancel the LCF function

Set "LCF (LOW CUT)" to "OFF" in step 3.

Starting to Record Automatically in Response to Sound – the VOR Function

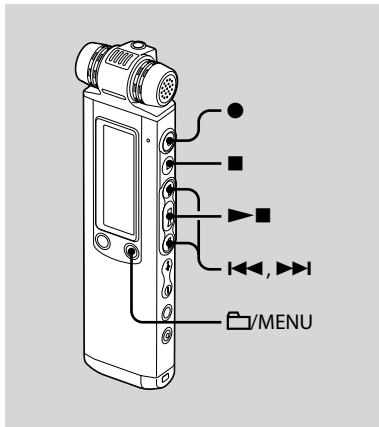

You can set the VOR (Voice Operated Recording) function to “ON,” to make the IC recorder start recording when the IC recorder detects sound, and pause when no sound is heard, eliminating recording during soundless periods.

The VOR function is set to “OFF” when you purchase the IC recorder.

- 1 Press and hold /MENU to enter the menu mode.

The menu mode window will be displayed.

- 2 Press or to select “VOR,” then press .

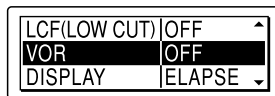

- 3 Press or to select “ON,” then press .

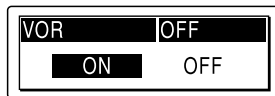

- 4 Press (stop) to exit the menu mode.

- 5 Press (record/pause).



“**REC**” and “**VOR**” appear in the display window.

The recording starts when the IC recorder detects sound. The recording pauses when no sound is detected and “VOR” and “” flash. When the IC recorder detects sound again, the recording starts again.

To cancel the VOR function

Set “VOR” to “OFF” in step 3.

Notes

- The VOR function is affected by the sound around you. Set “REC LEVEL” in the menu according to the recording conditions. If recording is not satisfactory after you have changed the microphone sensitivity, or for an important recording, set “VOR” to “OFF” in the menu.
- If you press  (record/pause) to pause recording during VOR recording, only “” flashes.
- During synchronized recording (page 51), manual recording (page 35), and pre-recording (page 38), the VOR function does not work.

Dividing a Message into Two During Recording

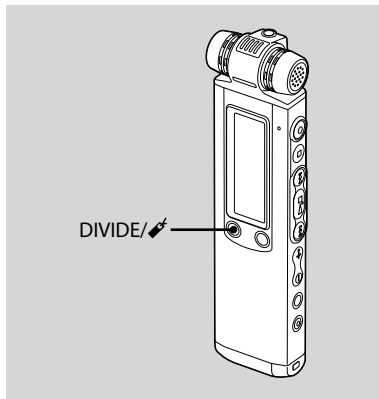

You can divide a message during recording so that the message is divided into two parts, and a new message number is added to the newer part of the divided message.

Press **DIVIDE**/ during recording.

An animation appears on the display and the new message number is added at the point you pressed the button. The message will be recorded as two messages, however recording continues without stopping.

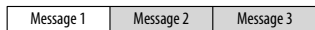

▲
Message is divided.
Message 2 and Message 3 are recorded
without stopping.

Tip

You can divide the currently recorded message during recording pause.

Notes

- You need a certain amount of free space in the memory to divide a message. For more information, see “System Limitations” on page 123.
- If 999 messages have been recorded in a folder, you cannot divide a message in that folder.
- Once a message is divided, you cannot re-combine the divided messages using the IC recorder.
- You cannot divide a message at the very beginning (0.5 seconds from the beginning) of the message.
- When you divide a message into two, at the point of division, the end of the first message and the beginning of the second message may be interrupted.
- During synchronized recording (page 51), you cannot divide a message.
- If you divide messages too frequently while the unit is recording them, the following phenomenon may occur: The operation indicator keeps flashing, and you cannot operate the unit for a certain period. This is not a malfunction. Wait until the operation indicator goes off.

Adding a Recording to a Previously Recorded Message

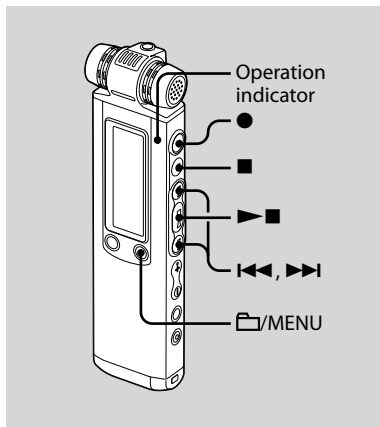

When "ADD/OVERWRITE" in the menu is set to "ADD," you can add a recording to the message being played back. The added recording will be placed after the current message, and will be counted as a part of the message.

During playback of Message 3

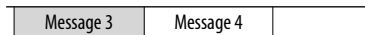

After adding a recording

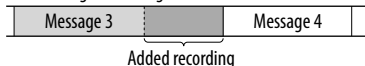

Select the message to which you want to add a recording first.

1 Press and hold /MENU to enter the menu mode.

The menu mode window will be displayed.

2 Press or to select "ADD/OVERWRITE," then press .

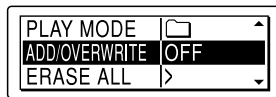

3 Press or to select "ADD," then press .



4 Press **■** (stop) to exit the menu mode.

5 When the message to be added is played back, press **●** (record/pause).

“ADD REC? [REC] TO EXECUTE” appears.

For details on playback, see page 54.



6 While “ADD REC? [REC] TO EXECUTE” is displayed, press **●** (record/pause).

The operation indicator will turn red. The new recording will be added at the end of the current message.

7 Press **■** (stop) to stop recording.

■ Notes

- You cannot add a recording when the message file has reached the maximum size limit (1 GB with LPEC files or MP3 files and 2 GB with LPCM files).
- You cannot add a recording to an LPCM file or an MP3 file that was not recorded using the IC recorder.
- If 10 minutes have passed after step 5, you must start the procedure again from step 5.
- You cannot add a recording if the remaining memory is insufficient.
- The added portion of a message will be recorded in the same recording mode.

Adding an Overwrite Recording during Playback

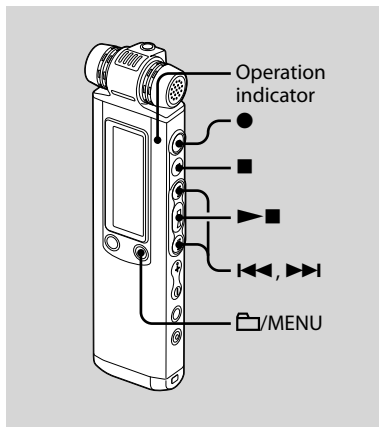

When "ADD/OVERWRITE" in the menu is set to "OVERWRITE," you can add an overwrite recording after a selected point in a recorded message. The part of the message after the selected point is deleted.

The starting point of an overwrite recording

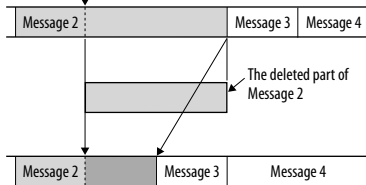

▲
Added overwrite recording in Message 2

Select the message to which you want to add an overwrite recording first.

1 Press and hold 📁/MENU to enter the menu mode.

The menu mode window will be displayed.

2 Press ◀◀ or ▶▶ to select "ADD/OVERWRITE," then press ▶■.

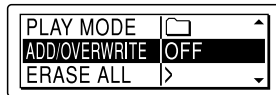

- 3** Press **◀◀** or **▶▶** to select **“OVERWRITE,”** then press **▶**.

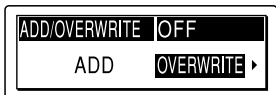

- 4** Press **■** (stop) to exit the menu mode.

- 5** When the message to be overwritten is played back, press **●** (record/pause).

“OVERWRITE REC? [REC] TO EXECUTE” appears.

For details on playback, see page 54.

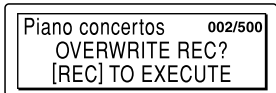

- 6** While **“OVERWRITE REC? [REC] TO EXECUTE”** is displayed, press **●** (record/pause).

The operation indicator will turn red. Then recording starts.

- 7** Press **■** (stop) to stop recording.

Notes

- You cannot add an overwrite recording to a file other than an LPCM file when the message/music file has reached the maximum size limit (1 GB). You can add an overwrite recording to an LPCM file, even if the message/music file has reached the maximum size limit (2 GB), when the beginning of the point to be overwritten has not reached the maximum size limit.
- You cannot add an overwrite recording to an LPCM file or MP3 file which was not recorded using the IC recorder.
- If 10 minutes have passed after step 5, you must start the procedure again from step 5.

Recording with an External Microphone

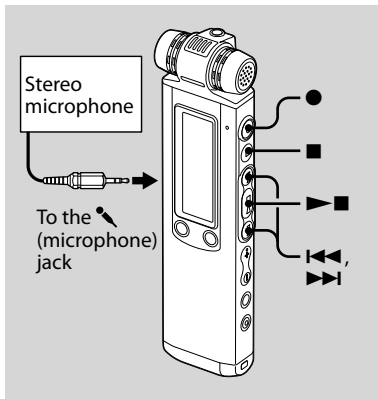

Tip

Before you start recording, we recommend you make a trial recording first.

- 1 **Connect an external microphone to the (microphone) jack when the IC recorder is in the stop mode.**

"SELECT INPUT" appears in the display window.

- 2 Press **◀◀** or **▶▶** to select "MIC IN," then press **▶■**.

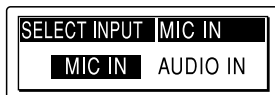

- 3 Press **●** (record/pause) to start recording.

The built-in microphones are automatically cut off.

If the input level is not strong enough, adjust the recording level on the IC recorder.

When a plug in power type microphone is connected, power is automatically supplied to the microphone from the IC recorder.

Note

If "SELECT INPUT" is not displayed, set it in the menu (page 89).

Recommended microphones

You can use the Sony ECM-CS10, or ECM-CZ10 electret condenser microphone (not supplied).

Recording sound from a telephone or a cell phone

You can use the supplied microphone or the ECM-TL1 headphone-type electret condenser microphone (not supplied) to record sound from a telephone or a cell phone.

Insert the earphone of the microphone into your ear, then, while holding the receiver to the ear with the earphone in it, connect the plug of the earphone to the  jack of the IC recorder.

Notes

- After you have made the connection, check the sound quality of the conversation and the recording level before you start recording.
- If the beep of the telephone or a dial tone is recorded, the conversation may be recorded with lower level of sound. In this case, start recording after the conversation has started.
- The VOR function may not work, depending on the kind of telephone or the line condition.
- We assume no responsibility whatsoever for any inconvenience, even if you cannot record a conversation using the IC recorder.
- Your dealer may not handle some of the above listed optional accessories. Please ask the dealer for detailed information.

Recording from Other Equipment

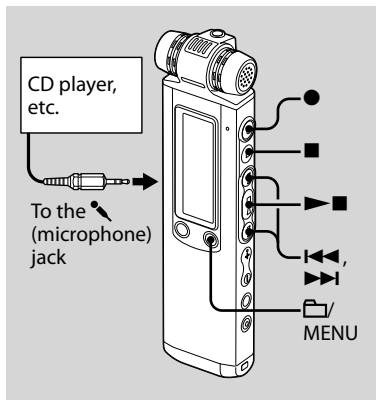

You can make music files without using the computer by recording the sound from other equipment, such as a CD player, connected to the IC recorder. When you use the synchronized recording function, the IC recorder enters the recording pause mode when no sound is detected for more than 2 seconds and the IC recorder starts recording again as a new message when sound is detected.

💡 Tip

Before you start recording, we recommend you make a trial recording first.

To record using the synchronized recording function

- 1 Press and hold /MENU to enter the menu mode.

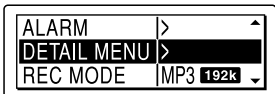

The menu mode window will be displayed.

- 2 Press  or  to select “DETAIL MENU,” then press .

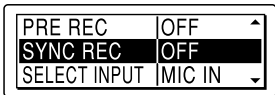

- 3 Press  or  to select “SYNC REC,” then press .



- 4 Press  or  to select “ON,” then press .

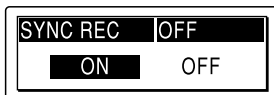



- 5 Press  (stop) to exit the menu mode.

- 6 Connect other equipment to the IC recorder when the IC recorder is in the stop mode.

Connect the audio output connector (stereo mini-plug) of other equipment to the  (microphone) jack of the IC recorder using an audio connecting cable*.

“SELECT INPUT” appears in the display window.

- 7 Press  or  to select “AUDIO IN,” then press .

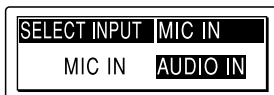

- 8 Press **●** (record/pause) to start recording.

“**● || SYNC**” flashes and the IC recorder enters the recording pause mode.

- 9 Start playback on the component connected to the IC recorder.

“**REC SYNC**” appears on the display and synchronized recording starts.

The synchronized recording pauses when no sound is detected for more than 2 seconds, and “**● || SYNC**” flashes. The IC recorder starts recording again as a new message when sound is detected.

Notes

- During synchronized recording, you cannot divide a recording message (page 43), you cannot pause recording (page 29), you cannot record with the VOR function or you cannot record with the pre-recording function.
- Depending on the equipment connected to the IC recorder, the synchronized recording function may not operate properly due to a difference in the audio input level.

To record without using the synchronized recording function

- 1 Press and hold **☰**/MENU to enter the menu mode.

The menu mode window will be displayed.

- 2 Press **◀◀** or **▶▶** to select “DETAIL MENU,” then press **▶■**.

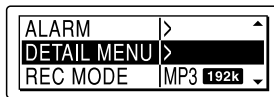

- 3 Press **◀◀** or **▶▶** to select “SYNC REC,” then press **▶■**.

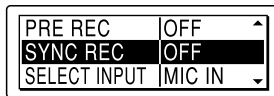

- 4 Press **◀◀** or **▶▶** to select “OFF,” then press **▶■**.

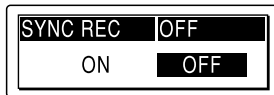

5 Press **■** (stop) to exit the menu mode.

6 Connect other equipment to the IC recorder when the IC recorder is in the stop mode.

Connect the audio output connector (stereo mini-plug) of other equipment to the  (microphone) jack of the IC recorder using an audio connecting cable*.

“SELECT INPUT” appears in the display window.

7 Press **◀◀** or **▶▶** to select “AUDIO IN,” then press **▶■**.

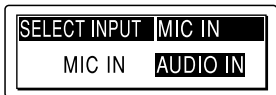

8 Press **●** (record/pause) to start recording.

The built-in microphones are automatically cut off and the sound from the connected equipment is recorded.

9 Start playback on the component connected to the IC recorder.

* Optional audio connecting cables (not supplied)

	To the IC recorder	To the other equipment
RK-G139	Stereo mini-plug	Mini-plug (monaural)
RK-G136	Stereo mini-plug	Stereo mini-plug

■ Notes

- If the input level is not strong enough, connect the headphone jack (minijack, stereo) of other equipment to the  (microphone) jack of the IC recorder in step 6 and adjust the volume level on the equipment connected to the IC recorder.
- If “SELECT INPUT” is not displayed, set it in the menu (page 89).
- Your dealer may not handle some of the above listed optional accessories. Please ask the dealer for detailed information.

Playing Back Messages

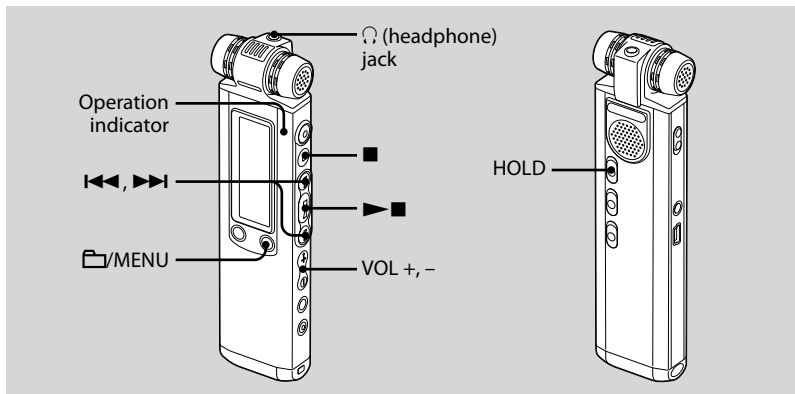

1 Select a folder.

- 1 Press **FOLDER/MENU**.
- 2 Press **I◀◀** or **▶▶I** to select the folder, then press **▶■**.

2 Press **I◀◀** or **▶▶I** to select the message you want to play.

3 Press **▶■** to start playback.

The operation indicator lights in green. (When "LED" is set to "OFF" in the menu (page 91), the operation indicator does not light.)



4 Press **VOL +** or **-** to adjust the volume.

5 Press **■** (stop) to stop playback.



Tip



During playback you can lock all the functions of all the buttons so that you can prevent inadvertent operations by sliding the HOLD switch in the direction of the arrow.

Listening with better sound quality



- **To listen with the headphones :**
Connect the stereo headphones to the  (headphone) jack. The built-in speaker will be automatically disconnected.
- **To listen from an external speaker:**
Connect an active speaker (not supplied) to the  (headphone) jack.

Quickly locating the point you wish to start playback (Easy Search)

When “EASY SEARCH” is set to “ON” (page 85) in the menu, you can quickly locate the point at which you wish to start playback by pressing  or  repeatedly during playback.

You can go back approx. 3 seconds by pressing  once, or advance approx. 10 seconds by pressing  once. This function is useful for locating a desired point in a long recording.

Searching forward/backward during playback (Cue/Review)

- **To search forward (Cue):** Press and hold  during playback and release it at the point you wish to resume playback.
- **To search backward (Review):** Press and hold  during playback and release it at the point you wish to resume playback.

The IC recorder searches at slow speed with playback sound first. This is useful to check one word forward or back. Then, if you press and hold the button, the IC recorder starts to search at higher speed.

When messages are played back to the end of the last message

- When you play back or fast play back to the end of the last message, "MESSAGE END" lights up for 5 seconds and the operation indicator lights up in green. (You cannot hear the playback sound.)
- When "MESSAGE END" and the operation indicator go off, the IC recorder will stop at the beginning of the last message.
- If you press and hold **⏮** while "MESSAGE END" is lit, the messages are played back rapidly, and normal playback will start at the point you release the button.
- If the last message is long and you wish to start playback at a later part of the message, press, hold **⏭** to go to the end of the message, then press **⏮** while "MESSAGE END" is lit to go back to the desired point.
- For messages other than the last one, go to the beginning of the next message and play backward to the desired point.

To	Do this
stop at the current position (Playback Pause function)	Press ■ (stop) or ▶■ . To resume playback from that point, press ▶■ again.
go back to the beginning of the current message*	Press ⏮ once.**
go back to previous messages	Press ⏮ repeatedly. (During stop mode, keep the button pressed to go back the messages continuously.)
skip to the next message*	Press ⏭ once.**
skip to the succeeding messages	Press ⏭ repeatedly. (During stop mode, keep the button pressed to skip the messages continuously.)

* If you have set a bookmark on the message, the IC recorder stops at the bookmark.

** These operations are for when "EASY SEARCH" is set to "OFF" (page 85).

Playing back a message repeatedly

During playback, press and hold ►■ until "↶1" appears. The selected message will be played back repeatedly.

To resume normal playback, press ►■ again.

Selecting the Playback Mode

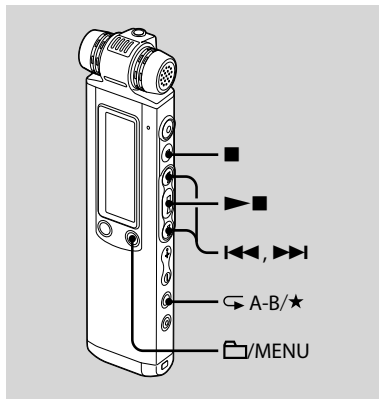

You can select the playback mode in the menu.

1 Press and hold /MENU to enter the menu mode.

The menu mode window will be displayed.

- 2 Press **◀** or **▶** to select "PLAY MODE," then press **■**.

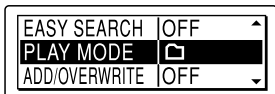

- 3 Press **◀** or **▶** to select "1," "1," "ALL," "1," "1," "1," or "ALL," then press **■**.

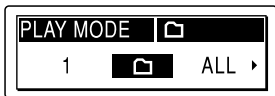

1	A message is played back.
	Messages in one folder are played back continuously.
ALL	All the messages are played back continuously.
1	One message is played back repeatedly.
	Messages in one folder are played back repeatedly.
ALL	All the messages are played back repeatedly.

- 4 Press **■** (stop) to exit the menu mode.

Playing back a specified section repeatedly – A-B Repeat

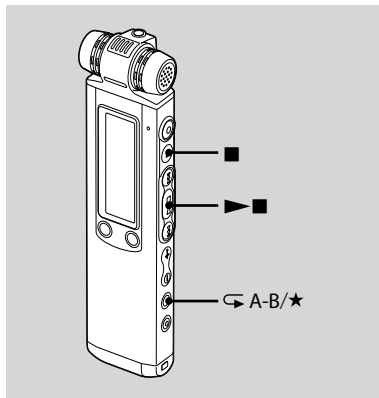

- 1 During playback, press (repeat) A-B/★ to specify the starting point A.

"A-B B?" is displayed.

- 2 Press (repeat) A-B/★ again to specify the finishing point B.

" A-B" is displayed and the specified section is played back repeatedly.

To resume normal playback

Press ►■.

To stop A-B Repeat playback

Press ■ (stop).

To change the segment specified for A-B Repeat playback

During A-B Repeat playback, press ⏮ (repeat) A-B/★ again to specify a new starting point A. Then specify a new finishing point B, as in step 2.



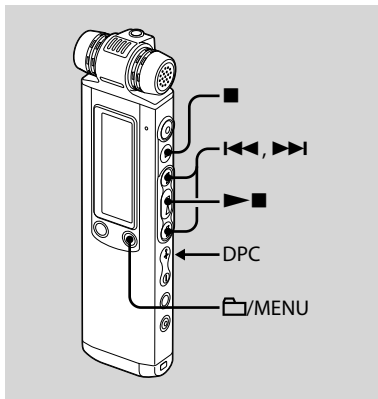

■ Notes

- You cannot set point A and point B at the very beginning (0.5 seconds from the beginning) or at the very end (0.5 seconds prior to the end) of the message.
- You cannot set point A and point B near a bookmark you have set (0.5 seconds before or after the bookmark).



Adjusting the Playback Speed – the DPC Function

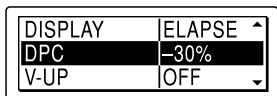

When you slide the DPC (Digital Pitch Control) switch to “ON,” you can adjust the playback speed between +200% and –75% of normal speed in the menu. The message is played back in natural tones by the digital processing function.

- 1 Slide the DPC switch to “ON.”
- 2 Press and hold /MENU to enter the menu mode.
The menu mode window will be displayed.
- 3 Press  or  to select “DPC,” then press .



- 4 Press  or  to adjust the speed of the playback, then press .

You can set the speed by 10% for + setting and by 5% for – setting.

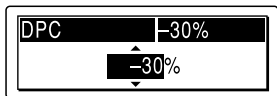

- 5 Press  (stop) to exit the menu mode.

To resume normal playback

Slide the DPC switch to “OFF.”

Reinforcing the Bass Sound

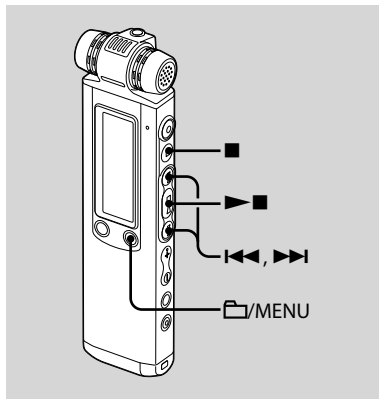

You can set the bass sound you want for the playback in the menu. However, when you play back using the built-in speaker, this setting does not work.

- 1 Press and hold /MENU to enter the menu mode.

The menu mode window will be displayed.

- 2 Press **◀◀** or **▶▶** to select “EFFECT;” then press **▶■**.

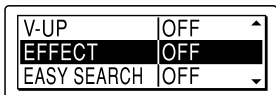

- 3 Press **◀◀** or **▶▶** to select the bass sound you want for the playback, then press **▶■**.

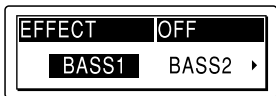

BASS 1 The bass sound is reinforced.

BASS 2 The bass sound is further reinforced.

OFF The bass sound cannot be reinforced.

- 4 Press **■** (stop) to exit the menu mode.

Note

The bass sound cannot be reinforced if the NOISE CUT switch is set to “ON.”

Reducing Distortion to Make the Human Voice Clearer – the Noise Cut Function

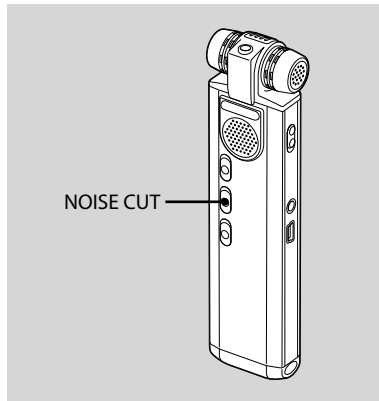

When the NOISE CUT switch is set to “ON,” the distortion of very low and high frequencies which are outside the human voice range is reduced, therefore you can hear the human voice more clearly.

When you are using the built-in speaker, the Noise Cut function does not work.

During playback set the NOISE CUT switch to "ON."

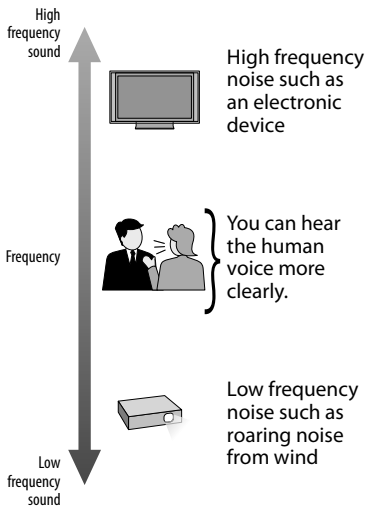

Notes

- The bass sound cannot be reinforced if the NOISE CUT switch is set to "ON."
- The effect of the Noise Cut function may be different depending on the condition of the recorded voice.

To cancel the Noise Cut function

Set the NOISE CUT switch to "OFF."

Adjusting the Playback Sound by Amplifying Inaudible Sound – the Digital Voice Up Function

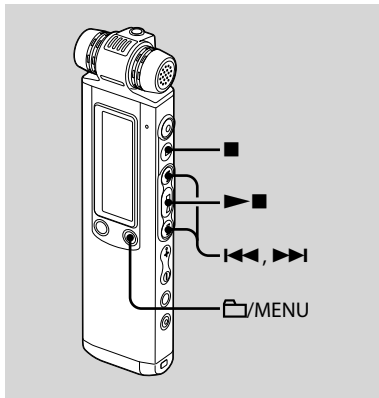

When you set “V-UP” to “MEDIUM” or “MAXIMUM,” the low-level part of a recorded message is amplified, allowing you to hear even low/small voices more easily.

- 1 Press and hold /MENU to enter the menu mode.

The menu mode window will be displayed.

- 2 Press or to select “V-UP,” then press .

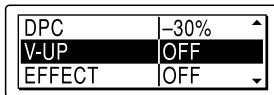

- 3 Press or to select “MEDIUM” or “MAXIMUM,” then press .

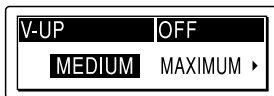

MEDIUM: You can adjust the Digital Voice Up function less finely.

MAXIMUM: You can adjust the Digital Voice Up function more effectively.

OFF: The Digital Voice Up function does not work.

- 4 Press (stop) to exit the menu mode.

To cancel the Digital Voice Up function

Set "V-UP" to "OFF" in step 3.

Adding a Bookmark

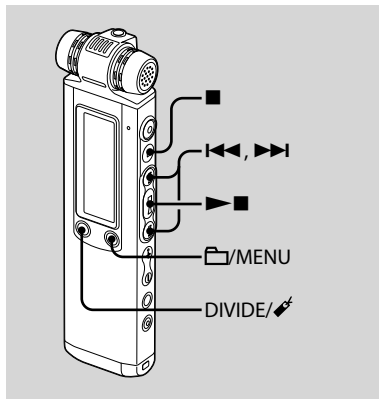

You can add a bookmark at a point in a message and use it during playback. You can add only one bookmark in each message.

During playback or stop, press and hold **DIVIDE/⏏** (bookmark) at the position you want to add a bookmark.

A bookmark is added and "⏏" (bookmark) flashes three times.

If you add a bookmark to a message that already has a bookmark, the previously added bookmark is deleted and a new bookmark is added at the newly specified point.

To start playback at the bookmark

Press **⏮** or **⏭** when the IC recorder is in the stop mode. When "⏏" (bookmark) flashes once, press **▶■**.

To delete the bookmark

- 1 Press and hold **☰**/MENU to enter the menu mode.

The menu mode window will be displayed.

- 2 Press **⏮** or **⏭** to select "ERASE BOOKMARK," then press **▶■**.

"ERASE BOOKMARK?" is displayed.

- 3 Press **⏮** or **⏭** to select "YES," then press **▶■**.

An erasing animation and "ERASING..." will appear and the bookmark will be deleted.

- 4 Press **■** (stop) to exit the menu mode.

Notes

- You cannot add a bookmark on MP3, LPCM, and WMA files.
- You cannot add a bookmark at the very beginning or at the very end of the message.

Recording with Other Equipment

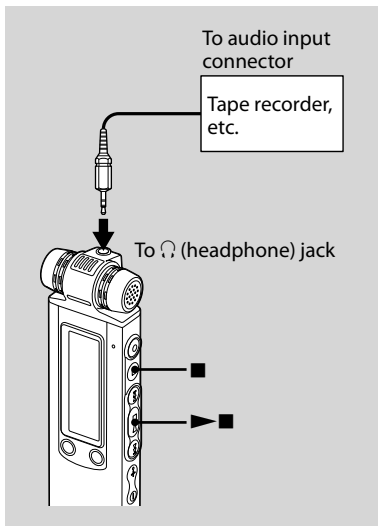

To record the sound of the IC recorder with other equipment, connect the ♪ (headphone) jack of the IC recorder to the audio input connector (minijack, stereo) of other equipment using an audio connecting cable* (not supplied).

- 1** Connect the ♪ (headphone) jack of the IC recorder to the audio input connector (stereo minijack) of other equipment using an audio connecting cable*.
- 2** Press ►■ to start playback and at the same time set the connected equipment to the recording mode.
A message from the IC recorder will be recorded on the equipment connected.
- 3** Press ■ (stop) on the IC recorder and the connected equipment at the same time to stop recording.

* Optional audio connecting cables (not supplied)

	To the IC recorder	To the other equipment
RK-G139	Stereo mini-plug	Mini-plug (monaural)
RK-G136	Stereo mini-plug	Stereo mini-plug

Tip

Before you start recording, we recommend you to make trial recording first.

Note

Your dealer may not handle some of the above listed optional accessories. Please ask the dealer for detailed information.

Playing Back a Message at a Desired Time with an Alarm

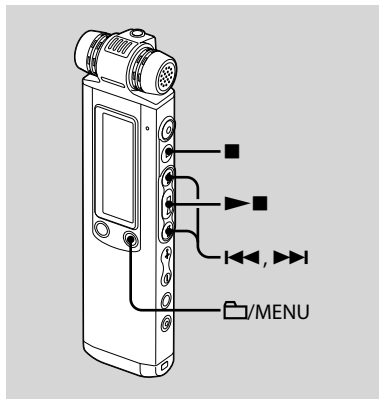

You can sound an alarm and start playback of a selected message at a desired time.

You can have the message played back on a specified date, once every week, or at the same time every day.

1 Select the message you want to play back with an alarm.

2 Enter the alarm setting mode.

- ① Press and hold /MENU to enter the menu mode.

The menu mode window will be displayed.

- ② Press or to select "ALARM," then press .



- ③ Press or to select "NEW," then press .

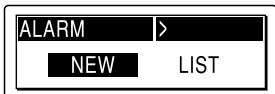

3 Set the alarm date and time.

- ① Press or to select "DATE," a day of the week, or "DAILY," then press .

② When you select "DATE":

Set the year, month, day, hour, and minute in sequence, as described in "Step 2: Setting the Clock" on page 19, then press , "EXECUTING..." then your settings are displayed.

When you select a day of the week or "DAILY":

Press or to set the hour, then press , press or to set the minute, then press . "EXECUTING..." then your settings are displayed.

The setting process is finished and "(●)" (alarm indicator) appears in the display window.

4 Press (stop) to exit the menu mode.

When the set date and time comes

At the set time, the alarm will sound for about 10 seconds while "ALARM" is displayed in the display window and the selected message will be played back. When the playback ends, the IC recorder will stop automatically at the beginning of that message.

To listen to the same message again

Press ►■, and the same message will be played back from the beginning.

To stop the alarm before the playback starts

Press ■ (stop) while the alarm sound is heard. You can stop the alarm playback even when the HOLD function is activated.

To change the alarm setting

1 Select "ALARM" – "LIST" in the menu, then press ►■.

The alarm list is displayed.

2 Press ◀◀ or ▶▶ to select the item you want to change, then press ►■.

3 Press ◀◀ or ▶▶ to select "EDIT," then press ►■.

4 Select "DATE," a day of the week, or "DAILY," then press ►■.

5 Set the date and time and press ►■.

"EXECUTING..." then your settings are displayed.

6 Press ■ (stop) to exit the menu mode.

To cancel the alarm setting

Follow steps 1 and 2 of “To change the alarm setting.” In step 3, select “CANCEL” and press **▶■**. “CANCEL ALARM?” is displayed. Press **◀◀** or **▶▶** to select “YES,” then press **▶■**. The alarm will be cancelled and the alarm indicator will disappear from the display window.

■ Notes

- You can set only one alarm each one message.
 - When the clock has not been set or no messages are recorded, you cannot set the alarm.
 - When **📁** is displayed for the folder indicator, you cannot set the alarm (page 67).
 - The alarm sounds even if you set “BEEP” to “OFF” in the menu (page 90).
 - If the alarm time comes during recording, the alarm will sound after the recording is finished. **🔔** will flash when the alarm time comes.
 - If the alarm time comes while you are erasing a message, the alarm will sound after the operation is finished.
 - If the alarm time comes while you are updating data, the alarm will be cancelled automatically.
 - If more than one alarm time comes, only the first message will be played back with an alarm.
- Once the alarm is set, the alarm will not be cancelled, even after the message is played back.
 - If the alarm time comes while another message is being played back with an alarm, the playback stops and the new message will be played back.
 - If the alarm time comes when you are setting the menu, the alarm will sound and the menu operation will be cancelled.
 - If you divide a message you have set an alarm for, the alarm setting remains on only the first part of the divided message.
 - If you delete a message on which you have set an alarm, that alarm will be also cancelled.

Editing Messages

Erasing Messages

You can erase the recorded messages one by one or all messages in a folder at a time.

Note

Once a recording has been erased, you cannot retrieve it.

Erasing messages one by one

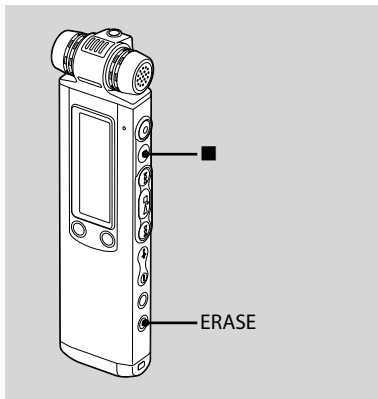

You can erase unwanted messages, retaining all other messages when the IC recorder is in the stop or playback mode. When a message is erased, the remaining messages will advance and be renumbered so that there will be no space between messages.

- 1 Press ERASE while playing back the message you want to erase or press and hold ERASE while the IC recorder is in the stop mode.**

The message title, message number, and “ERASE? [ERASE] TO EXECUTE” will be displayed and the message will be played back.

- 2 Press ERASE again while “ERASE? [ERASE] TO EXECUTE” is displayed.**

“ERASING...” will be displayed, one message will be erased, and the remaining messages will be renumbered.

To cancel erasing

Press ■ (stop) in step 1.

To erase another message

Proceed with the same steps again from the beginning.

To erase a part of one message

Divide the message into two messages first, then proceed with the same steps from the beginning.

Erasing all messages in a folder

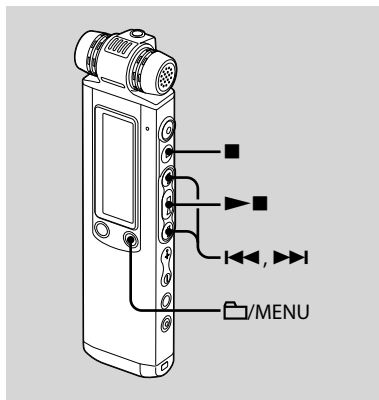

- 1** Select the folder containing the messages you want to erase when the IC recorder is in the stop mode.
- 2** Press and hold /MENU to enter the menu mode.

The menu mode window will be displayed.

- 3 Press **◀◀** or **▶▶** to select “ERASE ALL,” then press **▶■**.

“ERASE ALL?” appears.



- 4 Press **◀◀** or **▶▶** to select “YES,” then press **▶■**.



“ERASING ...” with animation appears and all messages in the selected folder will be erased.

- 5 Press **■** (stop) to exit the menu mode.



To cancel erasing

Select “NO” in step 4, then press **▶■**.

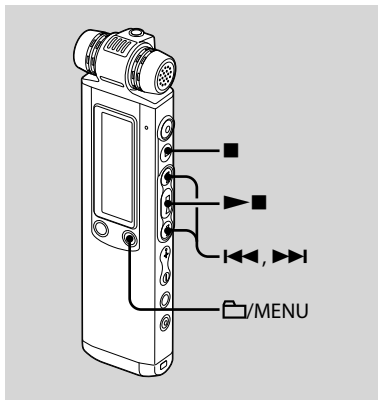
Moving a Message to a Different Folder







■ Notes

- When “” is displayed for the folder indicator, you cannot move a message (page 99).
- You cannot move a message to a  folder.

1 Select the message you want to move.





2 Press and hold /MENU to enter the menu mode.

The menu mode window will be displayed.

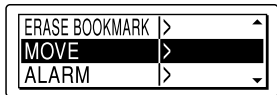
3 Press  or  to select “MOVE,” then press  .

The message to be moved will be played back.



4 Press  or  to select the folder that you want to move the message into, then press  .



“EXECUTING...” is displayed and the message is moved to the last position in the destination folder.

When you move a message to another folder, the original message in the previous folder will be deleted.

5 Press  (stop) to exit the menu mode.

To cancel moving the message

Press  (stop) before step 4.

Dividing a Message into Two

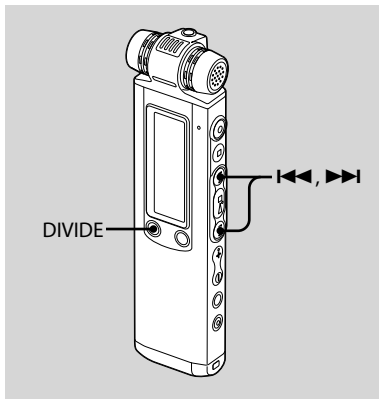

You can divide a message during playback, so that the message is divided into two parts and a new message number is added to the newer part of the divided message. By dividing a message, you can easily find the point from which you want to play back when you make a long recording such as at a meeting. You can divide a message until the total number of messages in the folder reaches 999 or until the



total number of messages in all folders reaches 1,012 if there are 5  folders.

- 1 Press **DIVIDE/**  (**bookmark**) while you are playing back the message you want to divide.

"DIVIDE? [DIVIDE] TO EXECUTE" appears with the message title or file name, and a message number.

- 2 Press **DIVIDE/**  (**bookmark**).

"DIVIDING..." with an animation appears, a new number is added to the newer part of the divided message, and the message numbers of the following messages will be incremented by one.



Message 1	Message 2	Message 3	
	 A Message is divided. 		
Message 1	Message 2	Message 3	Message 4

The message numbers are incremented.

Notes

- You need a certain amount of free space in the memory to divide a message. For more information, see “System Limitations” on page 123.
 - When you divide a message with a title and artist name, the newer part has the same title, and artist name.
 - If you divide a message with priority mark(s), the priority mark(s) will be added to both parts of the divided message.
 - If you divide a message at the position where you have set the bookmark, the bookmark will be deleted.
 - The recording time of the latter half of the divided message will be the same time as that of the divided position. If you divide an LPCM or MP3 file recorded using the IC recorder, the recording time of the latter file will be the same time as the original file.
 - If you divide a message during A-B repeat playback or one message repeat playback, the repeat setting will be cancelled.
 - If more than 10 seconds have passed after step 1, you must start the procedure again from the beginning.
 - You cannot divide a message other than the one recorded using the IC recorder (MP3/LPCM/WMA file transferred from a computer).
 - Once a message is divided, you cannot combine divided messages using the IC recorder.
- If you divide a message frequently, the unit may become unable to divide the message further.
 - If you divide a message with an alarm setting, the same alarm setting remains only with the former message divided.
 - You cannot divide a message at the very beginning (0.5 seconds from the beginning) or at the very end (0.5 seconds prior to the end) of the message.
 - You cannot divide a message within the range of 0.5 seconds before and after you have set a bookmark.
 - When  is displayed for the folder indicator, you cannot divide a message.

To play the divided message

Press  or  to display the message number, as the divided messages now each have message numbers.

Adding Priority Mark(s) – the Priority Mark Function

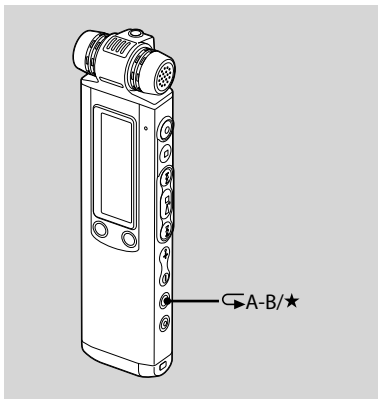

You can add priority marks (★) to important messages. There are four levels, “★★★★” (the most important), “★★★”, “★★”, and no priority mark. You can add priority marks both in the stop mode, and in the playback mode.

- 1 Select the message you want to mark.
- 2 Press and hold **A-B/★** (priority).
The “★” indicator will flash.
- 3 Press and hold **A-B/★** (priority) again to add the priority mark.
Each time you press and hold **A-B/★**, the priority mark(s) will change as follows:

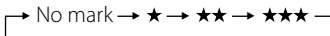

Notes

- You cannot add priority marks to an LPCM, MP3 or WMA file.
- When “” is displayed for the folder indicator, you cannot add a priority mark.

Preventing Accidental Operation – the HOLD function

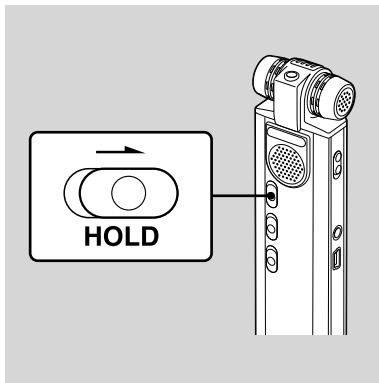

To prevent accidental operation, slide the HOLD switch in the direction of arrow in the recording or playback mode.

“HOLD” with the key mark and the current time will appear for 3 seconds indicating that all the functions of the buttons are locked.



To cancel the HOLD function

Slide the HOLD switch in the opposite direction from that of the arrow.

Note

When the HOLD function is activated during recording, cancel the HOLD function first to stop recording.

Tip

Even if the HOLD function is activated, you can stop the alarm playback. To stop the alarm or playback, press **■** (stop).

Making Settings for the Menu

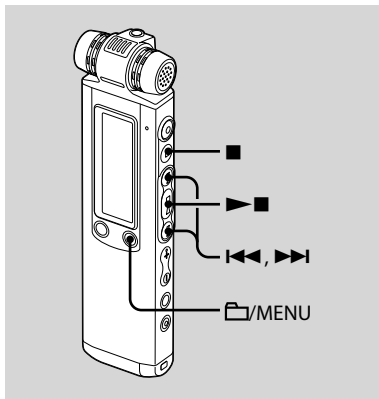

- 1** Press and hold /MENU to enter the menu mode.

The menu mode window will be displayed.



- 2** Press or to select the menu item for which you want to make setting, then press .

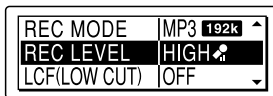

- 3** Press or to select the setting that you want to set, then press .



- 4** Press (stop) to exit the menu mode.

Note

If you do not press any button for one minute, the menu is automatically cancelled and the window will return to the normal display.









To return to the previous window

Press /MENU during menu setting.

To stop the menu operation in the middle





Press (stop).

Menu settings

Menu items	Settings	Operation mode (○ : the setting can be made/ — : the setting cannot be made)		
		Stop mode	Playback mode	Recording mode
REC MODE	MP3 48k , MP3 128k , MP3 192k , LPCM 22/16 , LPCM 44/16 , LPEC LP , LPEC SP , LPEC STLP , LPEC ST , LPEC STHQ	○	—	—
REC LEVEL	LOW  , HIGH  , S-HIGH  , MUSIC  , MANUAL	○	—	○
LCF (LOW CUT)	ON, OFF	○	—	○
VOR	ON, OFF	○	—	○
DISPLAY	ELAPSE, REMAIN, REC DATE	○	○	—
DPC	n% (n = -75 - +200)	○	○	—
V-UP	MEDIUM, MAXIMUM, OFF	○	○	—
EFFECT	BASS1, BASS2, OFF	○	○	—
EASY SEARCH	ON, OFF	○	○	—
PLAY MODE	1,  , ALL,  1,    ALL	○	○	—
ADD/OVERWRITE	ADD, OVERWRITE, OFF	○	—	—
ERASE ALL	ERASE ALL? → YES, NO	○	—	—
ERASE BOOKMARK	ERASE BOOKMARK? → YES, NO	○	—	—
MOVE	(Folder to be moved)	○	○	—







Menu items	Settings	Operation mode (○ : the setting can be made/ — : the setting cannot be made)		
		Stop mode	Playback mode	Recording mode
ALARM	NEW, LIST	○	—	—
DETAIL MENU		○	—	○
LIMITER	ON, OFF	○	—	○
PRE REC	ON, OFF	○	—	—
SYNC REC	ON, OFF	○	—	—
SELECT INPUT	MIC IN, AUDIO IN	○	—	○
DATE&TIME	AUTO, MANUAL	○	—	—
TIME DISPLAY	12-HOUR, 24-HOUR	○	—	—
FORMAT	ERASE ALL DATA? → YES, NO	○	—	—
BEEP	ON, OFF	○	—	—
LED	ON, OFF	○	—	—
BACKLIGHT	10 SEC, 60 SEC, OFF	○	—	—
MENU LANGUAGE	European model : ENGLISH, Русский (Russian) Other model : ENGLISH, Русский (Russian), 日本語 (Japanese), 한국어 (Korean), 简体中文 (Chinese), 繁體中文 (Chinese), ไทย (Thai)	○	—	—
USB CHARGE	ON, OFF	○	—	—



Menu items	Settings (*: Initial setting)	See page
REC MODE	Sets the recording mode. MP3 48k : Monaural standard recording mode. MP3 128k : Stereo standard recording mode. MP3 192k *: Stereo high-quality recording mode. LPCM 22/16 : Stereo long play high-quality recording mode. LPCM 44/16 : Stereo high-quality recording mode. LPEC LP : Monaural long play recording mode. LPEC SP : Monaural standard recording mode. LPEC STLP : Stereo long play recording mode. LPEC ST : Stereo standard recording mode. LPEC STHQ : Stereo high-quality recording mode.	30

Menu items	Settings (*: Initial setting)	See page
REC LEVEL	<p>Sets the microphone sensitivity.</p> <p>LOW  :</p> <p>To record dictation with a microphone in front of your mouth, a sound near the IC recorder, or a loud sound.</p> <p>HIGH *:</p> <p>To record the sound of a normal conversation or meeting, such as a recording made in a conference room or during interviews.</p> <p>S-HIGH  :</p> <p>To record a sound far away from the IC recorder or a low sound, such as a recording made in a spacious room.</p> <p>MUSIC  :</p> <p>To record more natural acoustic sound, as well as preventing sound distortion.</p> <p>MANUAL :</p> <p>During manual recording, you can adjust the recording level manually.</p>	33
LCF (LOW CUT)	<p>Sets the LCF (Low Cut Filter) function to cut a low frequency to reduce the roaring noise from wind; therefore you can record a message more clearly.</p> <p>ON:</p> <p>The LCF function is activated.</p> <p>OFF*:</p> <p>The LCF function is cancelled.</p>	41

Menu items	Settings (*: Initial setting)	See page
VOR	<p>Sets the VOR (Voice Operated Recording) function.</p> <p>ON: Recording starts when the IC recorder detects sound and pauses when no sound is heard, eliminating recording during soundless periods. The VOR function is activated when ● (record/pause) is pressed.</p> <p>OFF*: The VOR function does not work.</p> <p>Note If "REC LEVEL" is set to "MANUAL," the VOR function does not work.</p>	42
DISPLAY	<p>Changes the display mode in the playback/stop mode.</p> <p>ELAPSE*: Elapsed playback time of one message</p> <p>REMAIN: The remaining time of one message</p> <p>REC DATE: Date recorded</p>	–
DPC	<p>Sets the DPC (Digital Pitch Control) function.</p> <p>When you set the DPC switch to "ON," you can adjust the speed of the playback in a range from +200% to -75%. Set the speed by 10% for + setting and by 5% for – setting.</p> <p>–30%*</p>	59

Menu items	Settings (*: Initial setting)	See page
V-UP	<p>A low-level portion of a recorded message can be amplified, allowing you to hear even low/small voices more easily.</p> <p>MEDIUM: Adjusts the V-UP function less finely.</p> <p>MAXIMUM: Adjusts the V-UP function more effectively.</p> <p>OFF*: The V-UP function does not work.</p>	63
EFFECT	<p>Sets whether to reinforce bass sound during playback.</p> <p>BASS1: The bass sound is reinforced.</p> <p>BASS2: The bass sound is further reinforced.</p> <p>OFF*: The EFFECT function does not work.</p> <p>Note When playing back messages using a built-in speaker, the EFFECT function does not work.</p>	60
EASY SEARCH	<p>Sets the easy search function.</p> <p>ON: You can go forward for about 10 seconds by pressing ►► and go back for about 3 seconds by pressing ◀◀. This function is useful when attempting to locate desired point in a long recording.</p> <p>OFF*: The easy search function does not work. When you press ◀◀ or ►►, a message will be moved forward or backward.</p>	55

Menu items	Settings (*: Initial setting)	See page
PLAY MODE	<p>Sets the playback mode.</p> <p>1: A message is played back and the IC recorder stops after playback.</p> <p>*: Messages in one folder are played back continuously and the IC recorder stops after playback.</p> <p>ALL: All the messages are played back continuously and the IC recorder stops after playback.</p> <p> 1: One message is played back repeatedly.</p> <p> : Messages in one folder are played back repeatedly.</p> <p> ALL: All the messages are played back repeatedly.</p>	57
ADD/OVERWRITE	<p>You can add a recording to a previously recorded message or an overwrite recording during playback.</p> <p>ADD: You can add a recording.</p> <p>OVERWRITE: You can overwrite a recording.</p> <p>OFF*: You cannot add or overwrite a recording.</p>	45, 47
ERASE ALL	<p>All messages in the selected folder will be erased.</p> <p>Press /MENU to return to the folder window before erasing the messages and select a folder from which all messages are to be erased, then go to the menu window and select "YES."</p> <p>NO*: The erase function is cancelled.</p>	72

Menu items	Settings (*: Initial setting)	See page
ERASE BOOKMARK	The bookmark of the selected message will be cancelled. Press  /MENU to return to the folder window before erasing the bookmark and select a folder from which the bookmark is to be erased, then go to the menu window and select "YES." NO*: The erase function is cancelled.	65
MOVE	The selected message will be moved to the selected folder. Press  /MENU to return to the folder window before moving the message and select a folder from which the message is to be moved.	73
ALARM	Sets the alarm. NEW*: Set DATE for playback, SUN (Sunday), MON (Monday), TUE (Tuesday), WED (Wednesday), THU (Thursday), FRI (Friday), SAT (Saturday), or DAILY. LIST : A list of the message numbers, date, or the days of the week on which the alarm has already been set will be displayed. EDIT : You can change the selected date or day of the week. CANCEL: You can cancel the alarm on the selected date or on a day of the week.	67

Menu items	Settings (*: Initial setting)	See page
DETAIL MENU		
LIMITER	<p>Sets the input level automatically to prevent the sound distortion that occurs when a sound that is too loud is input.</p> <p>ON*: The LIMITER function is activated.</p> <p>OFF: The LIMITER function is cancelled.</p> <p>Note When "REC LEVEL" is set to "MANUAL," this setting is effective.</p>	37
PRE REC	<p>Allows you to record sound sources for a maximum of 5 seconds prior to the point when the recording is started. Sounds for 5 seconds are buffered in the memory.</p> <p>ON: The pre-recording function is activated.</p> <p>OFF*: The pre-recording function is cancelled.</p>	38
SYNC REC	<p>When set to "ON," the IC recorder enters the recording pause mode when no sound is detected for more than 2 seconds, and the IC recorder starts recording again as a new message when any sound is detected.</p> <p>ON: The synchronized recording function is activated.</p> <p>OFF*: The synchronized recording function is cancelled.</p> <p>Note You can record using the synchronized recording function only when you have connected other equipment to the IC recorder using an audio connecting cable and set "SELECT INPUT" to "AUDIO IN."</p>	51

Menu items	Settings (*: Initial setting)	See page
SELECT INPUT	Selects the external input to be recorded that is connected to the  (microphone) jack. MIC IN*: Select when you record messages using an external microphone. AUDIO IN: Select when you record using other equipment.	49, 50
DATE & TIME	Sets the clock. AUTO*: When the IC recorder is connected to a computer that is running the Digital Voice Editor, the clock will be automatically adjusted according to that computer. MANUAL: You can set the clock by setting year, month, day, hour, and minute in sequence.	19
TIME DISPLAY	Sets the clock display. 12-HOUR: 12:00AM = midnight, 12:00PM = noon 24-HOUR*: 0:00 = midnight, 12:00 = noon	–

Menu items	Settings (*: Initial setting)	See page
FORMAT	<p>Sets the formatting of the drive after “ERASE ALL DATA?” has been displayed.</p> <p>YES: The drive will be formatted.</p> <p>NO*: The drive will not be formatted.</p> <p>Notes</p> <ul style="list-style-type: none"> • Use the IC recorder formatting function to format the memory. If you format the IC recorder using your computer, the sound may be interrupted unexpectedly and the recording time may be shortened. • When you format the memory, all the data which you have stored in the IC recorder will be deleted. Once the data is deleted, you cannot retrieve it. 	–
BEEP	<p>Sets whether a beep will be heard or not.</p> <p>ON*: A beep will sound to indicate that an operation has been accepted.</p> <p>OFF: No beep sound will be heard.</p> <p>Note</p> <p>The alarm sounds even if you set “BEEP” to “OFF” in the menu.</p>	–

Menu items	Settings (*: Initial setting)	See page
LED	<p>Turns the operation indicator on or off during operation.</p> <p>ON*: During recording or playback, the operation indicator lights or flashes.</p> <p>OFF: The operation indicator does not light or flash, even during operation.</p> <p>Note When the IC recorder is connected to a computer, the operation indicator lights or flashes even if "LED" is set to "OFF."</p>	-
BACKLIGHT	<p>Turns the backlight in the display window on or off.</p> <p>10 SEC*: The backlight in the display window lights up for 10 seconds.</p> <p>60 SEC: The backlight in the display window lights up for 60 seconds.</p> <p>OFF: The backlight in the display window does not light, even during operation.</p>	-
MENU LANGUAGE	<p>Sets the language to be used for messages, menus, folder names, file names, etc.</p> <p>European model: ENGLISH*, Русский (Russian)</p> <p>Other models: ENGLISH*, Русский (Russian), 日本語 (Japanese), 한국어 (Korean), 简体中文 (Chinese), 繁體中文 (Chinese), ไทย (Thai)</p>	21

Menu items	Settings (*: Initial setting)	See page
USB CHARGE	<p>Sets whether batteries will be charged using a USB connection or not.</p> <p>ON*: The batteries will be charged.</p> <p>OFF: The batteries will not be charged.</p> <p>Note If you use a USB AC adaptor (not supplied) to connect the IC recorder to the AC outlet, you can charge batteries regardless this setting.</p>	–

What You Can Do Using the Computer

You can do the following when you connect the IC recorder to your computer using the supplied USB connecting cable.

Copying files from the IC recorder to your computer to save them (page 96)

You can copy the files and folders recorded on the IC recorder to save them.

Copying files from your computer to the IC recorder and playing them back (page 97)

You can copy WAV/MP3/WMA files saved on your computer by a simple drag & drop operation when you connect the IC recorder to your computer using the supplied USB connecting cable. You can also play back the copied files.

Managing and editing files using the Digital Voice Editor software (page 101)

The Digital Voice Editor software allows you to transfer the messages that you have recorded using the IC recorder to your computer to manage and edit them. You can also transfer music files saved on your computer to the IC recorder.

Using the IC recorder as a USB mass storage device (page 109)

You can store image data or text data saved on the computer temporarily in the IC recorder.

System requirements for your computer

To use your computer with the Digital Voice Editor software

To use your computer with the Digital Voice Editor software, see “System requirements” on page 103.

To use your computer without the Digital Voice Editor software

To use your computer with the IC recorder without the Digital Voice Editor software, or to use the IC recorder as a USB mass storage device, your computer must meet the operating system requirements and port environment described below.

Operating systems:

Windows Vista® Ultimate
Windows Vista® Business
Windows Vista® Home Premium
Windows Vista® Home Basic
Windows® XP Media Center Edition 2005 Service Pack 2 or higher
Windows® XP Media Center Edition 2004 Service Pack 2 or higher
Windows® XP Media Center Edition Service Pack 2 or higher

Windows® XP Professional Service Pack 2 or higher
Windows® XP Home Edition Service Pack 2 or higher
Windows® 2000 Professional Service Pack 4 or higher
Mac OS X (v10.2.8-v10.5)
Pre-installed.

Hardware Environment:

- Port: USB port
- Sound board: Sound cards compatible with any of the supported Microsoft® Windows® operating systems

Note

The following systems are not supported:

- 64 bit versions of Windows® XP
- Any operating systems other than the ones indicated above
- Personally assembled PCs or operating systems
- Upgraded operating systems
- Multi-boot environments
- Multi-monitor environments
- For the latest version information and compatibility with your operating system, please access the support home page for the IC recorder:

European model:

<http://support.sony-europe.com/DNA>

Other models:

<http://www.sony-asia.com/support>

Connecting the IC recorder to your computer

You can transfer the IC recorder data onto your computer by connecting the IC recorder to the computer.

Use the USB connecting cable supplied with the IC recorder to connect the  (USB) connectors of the IC recorder and your computer.

The IC recorder is recognized by the computer as soon as the cable is connected. You can connect or disconnect the cable when the IC recorder and the computer are turned on or off.

While the IC recorder is connected to the computer, "CONNECTING" is displayed in the display window of the IC recorder.

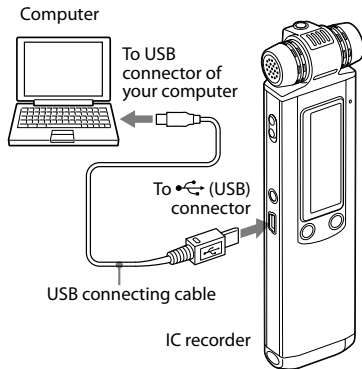

Notes

- Do not connect more than two USB devices to your computer. Normal operation will not be guaranteed.
- Use of this IC recorder with a USB hub or a USB extension cable is not guaranteed.
- A malfunction may occur depending on the USB devices connected at any one time.
- Before connecting the IC recorder to the computer, check that batteries are inserted in the IC recorder.
- It is recommended that you disconnect the cable from the computer when you do not use the Digital Voice Editor.

Disconnecting the IC recorder from your computer

Follow the procedures below; otherwise, data may be damaged.

- 1 Make sure that the operation indicator is not flashing.**
- 2 Disconnect the USB connecting cable connected to the IC recorder from the USB connector of the computer.**

On the Windows screen, left-click “Safely Remove Hardware” on the taskbar, and click “Safely remove USB Mass Storage Device.”

On the Macintosh screen, drag the “IC RECORDER” on the desktop to “Trash” and drop it there.

For details on disconnecting the IC recorder, refer to the operating instructions supplied with your computer.

Copying Files from the IC Recorder to Your Computer

You can save files or folders by transferring them from the IC recorder to your computer.

- 1 Connect the IC recorder to your computer (page 95).**

On the Windows screen; open “My Computer” and make sure that “IC RECORDER” has been recognized. On the Macintosh screen; make sure that an “IC RECORDER” drive is displayed on the desk top.

- 2 Copy files or folders you want to transfer to your computer.**

Drag and drop the folders contains files you want from “IC RECORDER” to the local disc on your computer.

To copy a folder (Drag and drop)

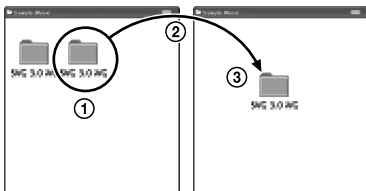

- 1 Click and hold,
- 2 drag,
- 3 and then drop.

Copying Files from Your Computer to the IC Recorder and Playing Them Back

You can copy music or the other audio files (WAV/MP3/WMA) from your computer to the IC recorder by dragging and dropping without using the Digital Voice Editor software, and you can play them back using the IC recorder.

The maximum playback time (tracks*), when playing music files using the IC recorder, is as follows.

	48 kbps	128 kbps
ICD-SX700	46 hr. 55 min. (703 tracks)	17 hr. 35 min. (263 tracks)
ICD-SX800	94 hr. 40 min. (1,420 tracks)	35 hr. 25 min. (531 tracks)

* In the case where tracks of 4 minutes each are transferred to the IC recorder.

1 Connect the IC recorder to your computer (page 95).

On the Windows screen; open “My Computer” and make sure that “IC RECORDER” has been recognized. On the Macintosh screen; make sure that an “IC RECORDER” drive is displayed on the desk top.

2 Copy the folder in which the music files are stored to the IC recorder.

On the Windows screen using Explorer, and on the Macintosh screen using Finder, drag and drop the folder onto the IC recorder.

The IC recorder can recognize up to 500 folders. You can copy up to 999 files to one folder and up to 5,000 files in total.

3 Remove the IC recorder from your computer, then press /MENU to select the folder you want.

4 Press or to select the file you want to play, then press .

5 Press to stop playback.



Notes

- When you copy a music file from your computer, you can play it back, however, you cannot divide it, or move it.
- To disconnect the IC recorder from your computer, refer to page 96.

Construction of folders and files

The folders and files are displayed on the computer screen as shown.

The folder indicators in the display window of the IC recorder are as follows:

-  Folder for messages recorded using the IC recorder (They have been already made when you purchase the IC recorder.)
-  Folder transferred from a computer (They are displayed when music files have been transferred from a computer.)

Note

A file cannot be played back, even if you transfer it to a VOICE folder.

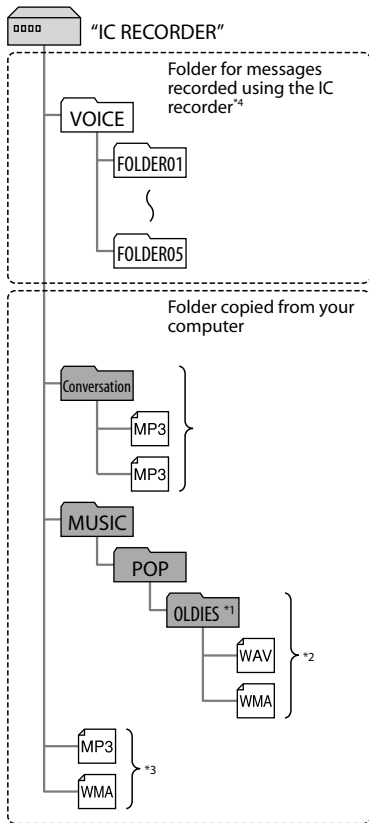

- ^{*1} The name of a folder in which music files are stored will be displayed on the IC recorder as it is, so it is convenient if you put an easy-to-remember name on the folder in advance. Folders shown in the illustration are examples of folder names.
- ^{*2} The IC recorder can recognize up to three levels of folders copied to the IC recorder, that is, up to “OLDIES” shown in the figure.
- ^{*3} If you copy music files separately, they are classified as being in “NO FOLDER.”
- ^{*4} Even if you transfer a file directly under the VOICE folder, the file cannot be played back. When you are going to transfer a file, transfer it into a folder in the VOICE folder.

Tip

You can enter title, or artist name, etc., into music files. The titles and artist names can be displayed on the IC recorder. It is useful if you input them using the software you use to make the music files on your computer.

Notes

- You cannot copy 511 or more folders (except for VOICE folders) or files to the root directory that is located immediately below “IC RECORDER” on the computer. This is due to FAT file system limitations. You cannot always transfer all files or folders, depending on either the number of characters you use in file or folder names, or the operating system.
- If no title, or artist name has been entered, “Unknown” will be displayed.
- If no title has been entered, a file name will be displayed.
- A title or artist name associated with an LPCM file cannot be displayed using the IC recorder. In this case, a file name will be displayed.
- To disconnect the IC recorder from your computer, refer to page 96.

Using the Supplied Digital Voice Editor Software

What You Can Do Using the Digital Voice Editor Software

The Digital Voice Editor software allows you to transfer messages that you have recorded using the IC recorder to your computer. You can save them on your computer, play them back, and edit them. You can also transfer music files saved on your computer to the IC recorder.

Transferring messages recorded on the IC recorder to your computer

You can save messages that you have recorded using the IC recorder on your computer's hard disk, by message, by folder, or all messages at one time. You can select a format to be used to save those messages as follows; MSV (LPEC) files, MSV (ADPCM) files, MP3 files, Windows standard WAV files.

Playing back messages on the computer

You can play back messages on the computer using the following functions, one-message repeat playback, A-B repeat playback, easy search, playback with a bookmark as well as normal playback. You can also adjust the playback speed.

Transferring messages saved on your computer to the IC recorder to play

You can transfer messages saved on your computer, as well as other files, such as voice files sent by e-mail, MSV (LPEC/ADPCM) files, WAV files, MP3 files, by file or by folder, to the IC recorder. You can also play them back using the IC recorder.

Editing messages saved on your computer or IC recorder using your computer

You can change message titles or user names, sort messages, set/delete priority marks or bookmarks, divide/combine messages, etc., on your computer, depending on the format of the file. You can change the order of the messages in

the IC recorder using the computer. You can also save messages saved on your computer by converting the voice format to a more appropriate one.

Other convenient uses

- You can send voice e-mail messages using MAPI e-mail software.
- You can transcribe your IC recorder messages using Dragon NaturallySpeaking® speech-recognition software (Only when Dragon NaturallySpeaking version 5.0 (or higher) Preferred or Professional Edition is installed on your computer).
- You can set/cancel the user name of the IC recorder, changing alarm settings, etc., on your computer.
- Using the CD Recording Tool for the Digital Voice Editor, you can play tracks of a CD in the computer's CD drive, and save CD tracks onto the PC hard disk in a file format that the Digital Voice Editor supports. Saved files can then be transferred to an IC recorder using the Digital Voice Editor.

- Using the CD Burning Tool for the Digital Voice Editor, you can make your original music CD or data CD from files recorded using the IC recorder, or from files saved on your computer's hard disk using the Digital Voice Editor.

Use of the CD Recording Tool for DVE is limited to the personal purposes.

Note

For information on using Dragon NaturallySpeaking, please refer to the documentation supplied with the software.

System requirements

To use the supplied software, your computer must meet the operating system requirements and hardware environment described below.

Operating Systems:

Windows Vista® Ultimate
Windows Vista® Business
Windows Vista® Home Premium
Windows Vista® Home Basic
Windows® XP Media Center Edition 2005
Service Pack 2 or higher
Windows® XP Media Center Edition 2004
Service Pack 2 or higher
Windows® XP Media Center Edition
Service Pack 2 or higher
Windows® XP Professional Service Pack 2
or higher
Windows® XP Home Edition Service Pack
2 or higher
Windows® 2000 Professional Service Pack
4 or higher
Pre-Installed

Hardware Environment:

- Computer: IBM PC/AT or compatible
- CPU : 266 MHz Pentium® II processor or higher (For Windows Vista®, 800MHz Pentium® III processor or higher)

- RAM: 128MB or more (For Windows Vista®, 512MB or more)
- Hard disk space: 150MB or more
- CD-ROM drive (When creating an audio CD or data CD, a CD-R/RW drive is needed)
- Port: USB port
- Sound board: Sound cards compatible with any of the supported Microsoft® Windows® operating systems
- Display: High color (16bit) or more and 800x480 dots or more
- Internet access for Voice Mail function and CD database service

Note

The following systems are not supported:

- 64 bit versions of Windows® XP
- Any operating systems other than the ones indicated above
- Personally assembled PCs or operating systems
- Upgraded operating systems
- Multi-boot environment
- Multi-monitor environment
- For the latest version information and compatibility with your operating system, please access the support home page for the IC recorder:

European model:

<http://support.sony-europe.com/DNA>

Other models:

<http://www.sony-asia.com/support>

Note on transcribing a message

When you use Dragon NaturallySpeaking® speech-recognition software to transcribe a message, your computer must also meet the system requirements that the Dragon NaturallySpeaking requires.

Note on sending a voice e-mail

When you use Microsoft® Outlook Express 5.0/5.5/6.0 to send a voice e-mail of a message, your computer must also meet the system requirements that the Outlook Express requires.

Installing the software

Install the Digital Voice Editor software on your computer's hard disk.

■ Notes

- 64 bit versions of Windows® XP are not supported.
- While installing the software do not connect or disconnect the USB connecting cable. The software may not be installed properly.
- When installing or uninstalling the software in Windows® 2000 Professional, make sure to log on Windows as the user name of "Administrator."
- When installing or uninstalling the software in Windows Vista® Ultimate/Windows Vista® Business/Windows Vista® Home Premium/Windows Vista® Home Basic/Windows® XP Media Center Edition 2005 Service Pack 2 or higher/Windows® XP Media Center Edition 2004 Service Pack 2 or higher/Windows® XP Media Center Edition Service Pack 2 or higher/Windows® XP Professional Service Pack 2 or higher/Windows® XP Home Edition Service Pack 2 or higher, log on as a user name with the "Computer administrator" user account. (To find if the user name has a "Computer administrator" user account, open the "User Accounts" from the "Control Panel" and refer to the section beneath the user name being displayed.)

- After installing, the Microsoft DirectX module is also installed depending on the operation system of your computer. This module is not deleted after uninstalling the software.
- Be sure to close all running programs before installing the Digital Voice Editor software.
- After installing the Digital Voice Editor software, do not install the “Memory Stick Voice Editor 1.0/1.1/1.2/2.0” software. The Digital Voice Editor will not work properly. (Using the IC recorder, you can save or edit the messages in the “Memory Stick”.)
- When the “Memory Stick Voice Editor 1.0/1.1/1.2/2.0” software has already been installed, installing the supplied software will automatically remove the “Memory Stick Voice Editor” software. (Messages are not removed.)

1 Make sure that the IC recorder is not connected, then turn on your computer and start up Windows.

2 Insert the supplied CD-ROM into the CD-ROM drive.

The [IC Recorder Software Setup] menu starts up automatically and the [Welcome to IC Recorder Software Setup] window appears. If the [Welcome to IC Recorder Software Setup] menu does not start up, open the [DVE] folder in the [Setup] folder on the CD-ROM, then double click [setup.exe].

3 Make sure that you accept the terms of the license agreement, select [I accept the terms of the license agreement], then click [Next].

The [Software Install] window appears.

4 Select [Digital Voice Editor], then click [Install].

Follow the instructions on the screen to make the settings required for installation.

If you have already installed a previous version of the Digital Voice Editor or any version of the “Memory Stick Voice Editor”

The dialog box used to uninstall a previous version of the Digital Voice Editor or any version of the “Memory Stick Voice Editor” will be displayed.

Follow the instructions on the screen to uninstall the software. The message files are not removed.

Note

If any illegal data modification is attempted, or a file is used for other than private purposes, the file may become unplayable or the Digital Voice Editor may become inoperable.

When the dialog box used to select how to save files is displayed

When you save files recorded using the IC recorder onto the computer named above, you can select whether you wish to convert them into the MP3 format. Select the desired setting.

When the dialog box used to select an ICD-P series is displayed

Select [Yes] to edit messages recorded using ICD-P series.

When the dialog box used to select the language to be used for the help is displayed

Click the language you want to use for the help.

5 When the [Ready to Install the Program] window appears, click [Install].

The installation starts.

6 When the [InstallShield Wizard Complete] window appears, select [Yes, I want to restart my computer now], then click [Finish].

The computer will be restarted.

When the computer has been restarted, installation is completed.

Uninstalling the software

When you wish to uninstall the software, follow the steps below.

For Windows 2000 or Windows XP

- 1 Click [Start] and select [Settings], [Control Panel], then [Add or Remove Programs] or [Add/Remove Applications].
- 2 Select [Digital Voice Editor 3] from the list and click [Remove] or [Change/Remove].
- 3 Follow the instructions on the screen.

For Windows Vista

- 1 Click [Start] – [Control Panel] – [Programs], then select and click [Uninstall a Program] from the category.
- 2 Select [Digital Voice Editor 3] from the list and click [Uninstall].
- 3 Click [Continue] in the [User Account control] window.
- 4 Follow the instructions on the screen.

Note

If you wish to move the software to another drive or directory after it is installed, you must uninstall the software first, then re-install it. The software does not work properly if you just move the software files.

Tip

Uninstallation does not remove the message files.

Referring to the help files

For details on each operation, refer to the help files.



The IC recorder can recognize up to 511 folders. When there is one file in each folder, you can create up to 340 folders, and when there are 5 folders, you can copy up to 1,012 files in total, with up to 999 files in one folder.

- 3 Remove the IC recorder from your computer, then press /MENU to select the folder you want.
- 4 Press or to select the file you want to play, then press .
- 5 Press to stop playback.

For details on using the Digital Voice Editor software, refer to the help files.

Transferring the files using the Digital Voice Editor software

- 1 Connect the IC recorder to your computer using the supplied USB connecting cable (page 95).
- 2 Start the Digital Voice Editor software and transfer music or language files from your computer to the IC recorder.

Using the IC Recorder as a USB Mass Storage Device

When the IC recorder is connected to your computer image data or text data on the computer, as well as messages or files recorded using the IC recorder can be temporarily stored in the IC recorder. For details on the system requirements, see page 94.

1 Connect the IC recorder to your computer using the supplied USB connecting cable (page 95).

On the Windows screen; open “My Computer” and make sure that “IC RECORDER” has been recognized. On the Macintosh screen; make sure that an “IC RECORDER” drive is displayed on the desk top.

2 Copy the folder of the data files to be stored to the IC recorder by dragging and dropping.

On the Windows screen using Explorer, and on the Macintosh screen using Finder, drag and drop the folder onto the IC recorder.

The IC recorder can recognize up to 500 folders. You can copy up to 999 files to one folder and up to 5,000 files in total.

Note



To disconnect the IC recorder from your computer, refer to page 96.





Troubleshooting

Before taking the IC recorder for repair, check the following sections. Should any problem persist after you have made these checks, consult your nearest Sony dealer.

IC recorder

Symptom	Remedy
The IC recorder cannot be turned off.	<ul style="list-style-type: none">• Slide the HOLD switch in the direction of the arrow when the IC recorder is stopped (page 25).
The IC recorder cannot be turned on.	<ul style="list-style-type: none">• The HOLD switch is set. Slide the HOLD switch in the direction opposite that of the arrow (page 25).
Display does not disappear. Display appears blurred.	<ul style="list-style-type: none">• Remove the protective film on the display window before you use the IC recorder.
The IC recorder does not operate.	<ul style="list-style-type: none">• The batteries have been inserted with incorrect polarity (page 14).• The batteries are weak (page 16).• The buttons are locked with the HOLD switch (page 78). (If you press any button, "HOLD" will flash for 3 seconds.)
No sound comes from the speaker.	<ul style="list-style-type: none">• The volume is turned down completely (page 54).• Headphones are plugged in (page 55).
Sound comes from the speaker even when the headphones are plugged in.	<ul style="list-style-type: none">• If you plug in the headphones not securely during playback, the sound may come from the speaker. Unplug the headphones and then insert them securely.

Symptom	Remedy
The operation indicator does not light.	<ul style="list-style-type: none">• “LED” is set to “OFF” (page 91). Display the menu and set “LED” to “ON.”
“MEMORY FULL” is displayed and you cannot start recording.	<ul style="list-style-type: none">• The memory is full. Erase some of the messages (page 71) or erase all the messages after you store them on your computer.
“FILE FULL” is displayed and you cannot operate the IC recorder.	<ul style="list-style-type: none">• 999 messages have been recorded in the selected  folder or 1,012 messages (when there are 5 folders) in total have been recorded. Therefore you cannot record another message, divide a message or move a message. Erase some of the messages (page 71) or erase all the messages after you store them on your computer.
You cannot add a recording or an overwrite recording.	<ul style="list-style-type: none">• As a factory setting, “ADD/OVERWRITE” in the menu is set to “OFF.” Display the menu and change “ADD/OVERWRITE” to “ADD” or “OVERWRITE” (pages 45, 47).• The remaining memory capacity is insufficient. The overwritten part will be deleted after the overwriting part finishes recording. Therefore, you can only overwrite within the remaining recording time.• You cannot add or overwrite a recording with an LPCM, WMA, or MP3 file that was not recorded using the IC recorder.• When  is displayed for the folder indicator, you cannot edit messages in that folder.
Recording is interrupted.	<ul style="list-style-type: none">• The VOR function (page 42) or the synchronized recording function is activated. Set “VOR” to “OFF” (page 84) or “SYNC REC” to “OFF” (page 88) in the menu.

Symptom	Remedy
Noise is heard.	<ul style="list-style-type: none"> • An object, such as your finger, etc., accidentally rubbed or scratched the IC recorder during recording so that noise was recorded. • The IC recorder was placed near an AC power source, a fluorescent lamp or a mobile phone during recording or playback. • Plug of the connected microphone was dirty when recording. Clean the plug. • The  (headphones) plug is dirty. Clean the plug. • Noise may be heard during recording pause of an MP3 file, VOR recording, or synchronized recording. Noise may also be heard at the point where you add a recording or overwrite a recording.
Recording level is low.	<ul style="list-style-type: none"> • “REC LEVEL” is set to “LOW  or . • If it is difficult to hear small sound of a recorded message, set “V-UP” to “MAXIMUM” or “MEDIUM” (page 63). Playback sound may become more audible.
When recording from other equipment, the input level is too strong or not strong enough.	<ul style="list-style-type: none"> • Connect the headphone jack of other equipment to the  (microphone) jack of the IC recorder and adjust the volume level on the equipment connected to the IC recorder.
Playback speed is too fast or too slow.	<ul style="list-style-type: none"> • The playback speed is adjusted in DPC. Slide the DPC switch to “OFF” or display the menu and adjust the speed in DPC again (pages 59, 84).

Symptom	Remedy
"--:--" is displayed.	<ul style="list-style-type: none">You have not set the clock (page 19).
"--y--m--d" or "--:--" is displayed.	<ul style="list-style-type: none">The date of recording will not be displayed if you recorded the message when the clock was not set.
There are fewer menu items displayed in the menu.	<ul style="list-style-type: none">The menu items displayed are different depending on the operation modes (stop mode, playback mode, and recording mode) (pages 80, 81).
The remaining time displayed in the display window is shorter than that displayed in the supplied Digital Voice Editor software.	<ul style="list-style-type: none">The IC recorder requires a certain amount of memory for system operation. That amount is subtracted from the remaining time, which is the reason for the difference.
The battery life is short.	<ul style="list-style-type: none">The battery life on page 17 is based on playback with the volume level set to 20. The battery life may shorten depending on the operation of the IC recorder.
There is no battery power remaining after you have left the batteries inserted for long time without using the IC recorder.	<ul style="list-style-type: none">Even if you do not use the IC recorder, the batteries are consumed slightly. The battery life in this case varies depending on humidity or other environmental conditions. Usually, the batteries last about four months. If you do not intend to use the IC recorder for an extended period of time, it is recommended that you turn the power off (page 25) or remove the batteries.

Symptom	Remedy
While you are charging the batteries, no animation of the battery indicator is displayed.	<ul style="list-style-type: none"> • You are not using rechargeable batteries. • Rechargeable batteries have been inserted with incorrect polarity. • The USB connecting cable is not connected properly. • “USB CHARGE” of “DETAIL MENU” is set to “OFF” in the menu. To charge the batteries using your computer, set it to “ON.” • While playing back messages using the built-in speaker, you cannot charge the batteries.
The animation of the battery indicator disappears in the middle of charging.	<ul style="list-style-type: none"> • Rechargeable batteries other than NH-AAA have been inserted. • The rechargeable batteries have deteriorated. • While playing back messages using the built-in speaker, you cannot charge the batteries.
COLD or HOT is flashing instead of the battery indicator.	<ul style="list-style-type: none"> • The environmental temperature is out of the range for charging. Charge the batteries in an environment with a temperature of 5 °C - 35 °C.
The battery life of the rechargeable batteries is short.	<ul style="list-style-type: none"> • You are using the rechargeable batteries in an environment with a temperature of under 5 °C. • The IC recorder has not been used for a certain time. Charge and discharge the rechargeable batteries using the IC recorder several times. • Replace the old ones with new rechargeable batteries. • The battery indicator is displayed only for a short time, however, the rechargeable batteries are not charged completely. It takes about 4 hours to fully charge exhausted batteries.
The changed menu setting does not function.	<ul style="list-style-type: none"> • If the batteries are removed just after the menu setting is changed, or the menu setting is changed using “IC Recorder Setting” of the Digital Voice Editor software with the exhausted batteries inserted, the menu setting may not function.

Symptom	Remedy
The "UPDATING DATABASE..." display does not disappear.	<ul style="list-style-type: none"> • If the IC recorder is required to process excessive amount of data, "UPDATING DATABASE..." may be displayed for an extended period of time. This is not a malfunction of the IC recorder. Wait until the message disappears.
You cannot connect the IC recorder to a computer.	<ul style="list-style-type: none"> • Refer to the help files of the Digital Voice Editor 3 software.
It takes time to start up the IC recorder.	<ul style="list-style-type: none"> • When there are many messages stored in the IC recorder, it may take time to start up. This is not a malfunction. Wait until the stop mode display appears.
The IC recorder does not operate correctly.	<ul style="list-style-type: none"> • Take out the batteries and insert them again (page 14).
The IC recorder does not operate.	<ul style="list-style-type: none"> • You may have formatted the memory of the IC recorder using the computer. Use the IC recorder formatting function to format the memory (page 90).
The IC recorder is not recognized by your computer. A folder/file cannot be transferred from your computer.	<ul style="list-style-type: none"> • Disconnect the IC recorder from your computer and reconnect it. • Do not use a USB hub or USB extension cable other than the supplied USB connecting cable. Connect the IC recorder to your computer using the supplied USB connecting cable. • Operation is not guaranteed if you use any system requirements other than those described on page 94. • Depending on the USB connector position, the IC recorder may not be recognized. If this happens, try another connector.
The file transferred from your computer cannot be played back.	<ul style="list-style-type: none"> • The file format may differ from those that can be played back using the IC recorder (.mp3/.wma /.msv/.wav) (page 101). Check the file name.

Symptom	Remedy
A file name is not displayed.	<ul style="list-style-type: none">• If an LPEC, MP3, or WMA file has no title, a file name is displayed instead. If you want to display a title, enter it using computer.• The title/artist name of an LPCM file cannot be displayed as title/artist name is not supported. In this case a file name is displayed.
Playback sound becomes loud unexpectedly.	<ul style="list-style-type: none">• "V-UP" is set to "MAXIMUM" or "MEDIUM." Set it to "OFF" (page 85).

Please note that recorded messages may be erased during service or repair work.

Digital Voice Editor

Refer to the Help files of the Digital Voice Editor software, too.

Symptom	Remedy
The Digital Voice Editor software cannot be installed.	<ul style="list-style-type: none">• The free disk or memory space on the computer is too small. Check the hard disk and memory space.• You are trying to install the software into the operating system that the Digital Voice Editor software does not support.• In Windows Vista® Ultimate/Windows Vista® Business/Windows Vista® Home Premium/Windows Vista® Home Basic/Windows® XP Media Center Edition 2005 Service Pack 2 or higher/Windows® XP Media Center Edition 2004 Service Pack 2 or higher/Windows® XP Media Center Edition Service Pack 2 or higher/Windows® XP Professional Service Pack 2 or higher/Windows® XP Home Edition Service Pack 2 or higher, you log on as a user name belonging to a user account with limitations. Make sure to log on as a user name with the “Computer administrator” user account.• In Windows® 2000 Professional, make sure to log on as the user name of “Administrator.”
The IC recorder or “Memory Stick” cannot be properly connected.	<ul style="list-style-type: none">• Check that the installation of the software has been successful. Also check the connection as follows:<ul style="list-style-type: none">– When using an external USB hub, connect the IC recorder directly to the computer.– Disconnect and then connect the cable with the IC recorder.– Connect the IC recorder to another USB connector.• Your computer may be in the system standby/hibernate mode. Do not let your computer enter into the system standby/hibernate mode while being connected to the IC recorder.



Symptom	Remedy
Messages cannot be played back./Playback sound volume is too low.	<ul style="list-style-type: none"> • No sound board is installed. • No speaker is built-in or connected to the computer. • The volume of the sound is turned down. • Turn up the volume on the computer. (Refer to the instruction manual of the computer.) • The volume of WAV files can be changed and saved using the "Increase Volume" feature of the Microsoft Sound Recorder.
Saved message files cannot be played back or edited.	<ul style="list-style-type: none"> • You cannot play back a message whose file format the Digital Voice Editor software does not support. Depending on the file format, you cannot use part of editorial features of the software.
Counter or slider moves incorrectly. There is noise.	<ul style="list-style-type: none"> • This happens when you play back messages that you divided, combined, overwrote, or added a recording. Save a message on your computer first, and then add it to the IC recorder. Select the saving file format that suits the IC recorder you use.
Operation is slow when there are many messages.	<ul style="list-style-type: none"> • When the total number of messages increases, the operation becomes slower, regardless of the length of the recording time.
Display does not work during saving, adding, or deleting of messages.	<ul style="list-style-type: none"> • It takes a longer time to copy or delete long messages. After completing operations, the display works normally.
It takes too long to convert a file format.	<ul style="list-style-type: none"> • The time required for file conversion becomes longer as the file size is bigger.

Symptom	Remedy
The software 'hangs' when the Digital Voice Editor software starts up.	<ul style="list-style-type: none"><li data-bbox="346 114 936 215">• Do not disconnect the connector of the IC recorder while the computer is communicating with the IC recorder. Otherwise the computer operations become unstable or the data inside the IC recorder may be damaged.<li data-bbox="346 225 936 274">• There may be conflict between the software and other driver or application.<li data-bbox="346 284 936 381">• Do not install the "Memory Stick Voice Editor" software and the Digital Voice Editor Ver. 2x software after you installed the Digital Voice Editor software. The Digital Voice Editor software may not operate properly.

Error messages

Error message	Cause/Remedy
BATTERY LOWER-LEVEL	<ul style="list-style-type: none">• You cannot format the memory or erase all the files in a folder because of insufficient battery power. Prepare new batteries to replace the current ones.
LOW BATTERY	<ul style="list-style-type: none">• Batteries are exhausted. Replace the old batteries with new ones. Or charge the rechargeable batteries or replace the old rechargeable batteries with new ones.
MEMORY FULL	<ul style="list-style-type: none">• The remaining memory capacity of the IC recorder is insufficient. Erase some messages before recording.
FILE FULL	<ul style="list-style-type: none">• When there are already 999 messages in the selected folder or the total number of the file stored in the IC recorder becomes maximum, you cannot record a new message. Erase some messages before recording a message.
FILE DAMAGED	<ul style="list-style-type: none">• You cannot play or edit messages, because the data of the selected file is damaged.
FORMAT ERROR	<ul style="list-style-type: none">• The IC recorder cannot be turned on using the computer because there is no copy of the control file required for operation. Format the IC recorder using the formatting function in the menu.
PROCESS ERROR	<ul style="list-style-type: none">• The IC recorder failed in memory access. Remove and then re-insert the batteries.• Save a backup copy of your data and format the IC recorder using the menu.

Error message	Cause/Remedy
SET DATE&TIME	<ul style="list-style-type: none"> • Set the clock; otherwise, you cannot set the alarm.
SET ADD/OVERWRITE	<ul style="list-style-type: none"> • “ADD/OVERWRITE” in the menu is set to “OFF.” You cannot add a recording or an overwrite recording.
NO FILE	<ul style="list-style-type: none"> • The selected folder does not have any messages. You cannot move a message or set the alarm, etc., because of this.
ALREADY SET	<ul style="list-style-type: none"> • You set the alarm to play back a message at a date and time previously set on another message. Change the alarm setting.
PAST DATE/TIME	<ul style="list-style-type: none"> • You set the alarm when the time has already passed. Check it and set the appropriate date and time.
NO SETTING	<ul style="list-style-type: none"> • If you have not set the alarm, the alarm list will not be displayed. Make the alarm setting for “NEW.” • If you have not set any bookmark on a message, you cannot cancel it.
FILE PROTECTED	<ul style="list-style-type: none"> • The selected message is protected and is now a “Reading only” file. You cannot erase it. Cancel “Reading only” on your computer to edit the message using the IC recorder.
UNKNOWN DATA	<ul style="list-style-type: none"> • The data does not have a file format which the IC recorder supports. • A file of which copyright is protected cannot be played back.

Error message	Cause/Remedy
CANNOT OPERATE	<ul style="list-style-type: none"> • If the selected file is an LPCM file or an MP3 file, you cannot add priority marks or bookmarks. If the selected file is a WMA file, you cannot add priority marks or bookmarks, divide a message, add a recording, or overwrite a recording. • If  is displayed for the folder indicator, you cannot add priority marks or bookmarks, divide a message, add a recording, or overwrite a recording. • You cannot move a message or divide a message, because there is more than one folder that has files with same name. Change the file names.
INVALID IN MANUAL SETTING	<ul style="list-style-type: none"> • "REC LEVEL" in the menu is set to "MANUAL."The VOR function does not work and you cannot set the microphone sensitivity.
MANUAL SETTING ONLY	<ul style="list-style-type: none"> • "REC LEVEL" in the menu is not set to "MANUAL."The LIMITER function does not work.
FULL SETTING	<ul style="list-style-type: none"> • You can set up to 30 alarms. Cancel unwanted alarms.
NEW TRACK	<ul style="list-style-type: none"> • When the recording message/music file size exceeds the maximum size limit (1GB for MP3 or LPEC files, 2 GB for LPCM files), exceeded recording is recorded as a new message.
CHANGE FOLDER	<ul style="list-style-type: none"> • If there are no files in the  folder, no folders are displayed in the display window, therefore, the folder setting will be changed.
INVALID IN [NOISE CUT] ON	<ul style="list-style-type: none"> • When the NOISE CUT switch is set to "ON," the setting of the EFFECT menu does not work.
SYSTEM ERROR	<ul style="list-style-type: none"> • A system error other than the above has occurred. Remove the batteries and re-insert them.

System limitations

There are some system limitations of the IC recorder. Troubles as mentioned below are not malfunctions of the IC recorder.

Symptom	Cause/Remedy
You cannot record messages up to the maximum recording time.	<ul style="list-style-type: none"> If you record messages in a mixture of the recording modes, the recordable time varies from the maximum LPCM 44/16 mode recording time to the maximum LPEC LP mode recording time. The sum of the number on the counter (elapsed recording time) and the remaining recording time may be less than the IC recorder's maximum recording time.
You cannot display music files in order.	<ul style="list-style-type: none"> If you have transferred music files using your computer, those files may not be copied in order of transfer because of the System limitations.
A message/music file is automatically divided.	<ul style="list-style-type: none"> The message/music file has reached the maximum size limit (1 GB for an MP3 or LPEC file, 2 GB for an LPCM file), therefore it is automatically divided.
You cannot enter lower-case characters.	<ul style="list-style-type: none"> Depending on the combination of the characters used for the folder name that was made on your computer, those characters may change to all capitals.
"□" is displayed in place of a folder name, title, artist name, or file name.	<ul style="list-style-type: none"> A character that cannot be displayed on the IC recorder has been used. Using your computer, replace it with one that can be displayed on the IC recorder. Messages with names that include disallowed characters may not be played back.
When you set A-B Repeat playback, the set positions move a little.	<ul style="list-style-type: none"> Depending on the files transferred to the IC recorder from your computer, the set positions may move.

Symptom	Cause/Remedy
You cannot divide a message while you are recording.	<ul style="list-style-type: none">• If there is insufficient memory available, you may not divide a message.
When you divide a message during recording, the recording is interrupted at the beginning of the divided message.	<ul style="list-style-type: none">• Depending on the remaining memory, the recording may be interrupted at the beginning of the divided message.

Using a USB AC Adaptor (not supplied)

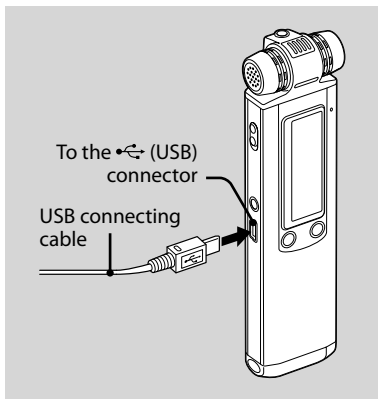

You can charge the rechargeable batteries by connecting the IC recorder to an AC outlet using a USB AC adaptor AC-U50A (not supplied).

You can charge the batteries while you are using the IC recorder, so that it is useful when you want to record for a long time.

Note

Your dealer may not handle some of the optional accessories. Please ask the dealer for detailed information.

- 1 Connect the USB connecting cable supplied to the (USB) connector of the IC recorder.**
- 2 Connect a USB AC adaptor (not supplied) to the USB connecting cable.**
- 3 Connect the USB AC adaptor to an AC outlet.**

Now you can use the IC recorder while changing the batteries.

While the batteries are charging, the battery indicator are displayed in an animation.

When the battery indicator indicates "FULL," charging is completed. (Charging time: approx. 4 hours*)

When you use the IC recorder for the first time, or after you have not used the IC recorder for a certain time, it is recommended that you charge the batteries repeatedly until “**FULL**” is displayed.

If the battery indicator is not displayed, charging has not been done properly. Proceed from step 1 again.

* This is an approximation for the time it takes to charge from no remaining battery power to full battery power at room temperature. It varies depending on the remaining power and the condition of the batteries. It also takes more time if the temperature of the batteries is low, or if the batteries are charged while you are transferring data to the IC recorder.

Disconnecting the IC recorder from the AC outlet

Follow the procedures below; otherwise, data may be damaged.

- 1 If you are recording or playing back a message, press  (stop) to put the IC recorder into the stop mode.**
- 2 Make sure that the operation indicator is not flashing.**
- 3 Disconnect the USB AC adaptor from the AC outlet, then disconnect the IC recorder from the USB AC adaptor.**

Notes

- While “**COLD**” or “**HOT**” is being displayed instead of the battery indicator, you cannot charge the batteries. Charge the batteries in an environment with a temperature of 5 °C –35 °C.
- While playing back messages using the built-in speaker, you cannot charge the batteries.

- During recording (the operation indicator lights or flashes in red) or accessing data (the operation indicator flashes in orange),
 - the IC recorder should not be connected to or disconnected from the USB AC adaptor connected to the AC outlet.
 - the USB AC adaptor connected to the IC recorder should not be connected to or disconnected from the AC outlet.

Doing so may damage the data. If the IC recorder is required to process a large amount of data, the start-up window may be displayed for an extended period of time. This is not a malfunction of the IC recorder. Wait until the start-up display disappears from the display window.

- While a USB AC adaptor (not supplied) is being used, the battery indicator does not appear in the display window.

Precautions

On power

- Operate the unit only on 2.4 V or 3.0 V DC. Use two NH-AAA rechargeable batteries or two LR03 (size AAA) alkaline batteries.

On safety

- Do not operate the unit while driving, cycling or operating any motorized vehicle.

On handling

- Do not leave the unit in a location near heat sources, or in a place subject to direct sunlight, excessive dust or mechanical shock.
- Should any solid object or liquid fall into the unit, remove the batteries and have the unit checked by qualified personnel before operating it any further.

On noise

- Noise may be heard when the unit is placed near an AC power source, a fluorescent lamp or a mobile phone during recording or playback.
- Noise may be recorded when an object, such as your finger, etc., rubs or scratches the unit during recording.

On maintenance

- To clean the exterior, use a soft cloth slightly moistened in water. Do not use alcohol, benzine or thinner.

If you have any questions or problems concerning your unit, please consult your nearest Sony dealer.

Backup recommendations

To avoid potential risk of data loss caused by accidental operation or malfunction of the IC recorder, we recommend that you save a backup copy of your recorded messages on a tape recorder or to a computer, etc.

Specifications

IC recorder section

Capacity (User available capacity)

ICD-SX700:

1 GB (approx. 970 MB =1,017,610,240 Byte)

ICD-SX800:

2 GB (approx. 1.9 GB =2,047,737,856 Byte)

A part of the memory capacity is used as a management area.

Recording time*1

See page 32.

*1 When you are going to record continuously for a long time, you may have to replace the batteries with new ones in the midst of recording. For details on the battery life, refer to page 17.

Frequency range

- LPCM 44/16: 50 - 20,000 Hz
- LPCM 22/16: 50 - 10,000 Hz
- MP3 192k: 50 - 16,000 Hz
- MP3 128k: 50 - 16,000 Hz
- MP3 48k: 50 - 14,000 Hz
- LPEC STHQ: 50 - 20,000 Hz
- LPEC ST: 50 - 16,500 Hz
- LPEC STLP: 50 - 7,000 Hz
- LPEC SP: 50 - 6,000 Hz
- LPEC LP: 50 - 3,500 Hz

Bit rates and sampling frequencies for MP3 files*2

Bit rate: 32 - 320 kbps, VBR

Sampling frequencies: 16/22.05/24/32/44.1/48 kHz

*2 The playback of MP3 files recorded using the IC recorder is also supported.
Not all encoders are supported.

Bit rate and sampling frequencies*3 for WMA files

Bit rate: 32 - 192 kbps, VBR

Sampling frequencies: 44.1 kHz

*3 WMA Ver. 9 is compatible, however, MBR (Multi Bit Rate), Lossless, Professional, and Voice are not supported.
A file of which copyright is protected cannot be played back.
Not all encoders are supported.

General

Speaker

Approx. 16 mm dia.

Power output

150 mW

Input/Output

- Microphone jack (minijack, stereo)
 - input for plug in power, minimum input level 0.9 mV, 3 kilohms or lower impedance microphone
- Headphone jack (minijack, stereo)
 - output for 8 - 300 ohms headphones
- USB connector
 - High-Speed USB compatible

Playback speed control (DPC)

–75% to +200%

Power requirements

Two NH-AAA rechargeable batteries: 2.4 V DC
Two LR03 (size AAA) alkaline batteries: 3.0 V DC

Operating temperature

5°C - 35°C

Dimensions (w/h/d) (not incl. projecting parts and controls) (JEITA)*⁵

31.3 × 130.0 × 15.4 mm

Mass (JEITA)*⁵

Approx. 75 g including NH-AAA rechargeable batteries

*⁵ Measured value by the standard of JEITA
(Japan Electronics and Information
Technology Industries Association)

Supplied accessories

See page 7.

Optional accessories

Active speaker SRS-T80, SRS-T88
Electret condenser microphone ECM-CS10,
ECM-CZ10, ECM-TL1
Audio connecting cable RK-G136, RK-G139
(excluding Europe)
USB AC adaptor AC-U50A
Rechargeable battery NH-AAA-B2K
Battery charger BCG-34HS2KA

Your dealer may not handle some of the above listed optional accessories. Please ask the dealer for detailed information.

Design and specifications are subject to change without notice.

Index

A

- A-B Repeat58
- Adding an Overwrite Recording.....47, 86
- Adding a Recording.....45, 86
- Adjusting the volume29, 54
- Alarm.....67, 87

B

- Battery7, 14, 16
- Battery indicator.....14, 16
- Battery life17
- Beep.....90
- Bookmark64, 87
- Built-in microphones.....28, 36

C

- Connecting the IC recorder to your computer.....95
- Copying Files from Your Computer.....97
- Copying Files to Your Computer.....96
- Cue55
- Cutting out low frequency41, 83

D

- Digital Voice Editor.....7, 101
 - Installing.....104
- DIRECTNL switch.....29
- Display window
 - During playback and stop.....10
 - During recording.....12
- Dividing a message.....43, 75, 86
- DPC (the Digital Pitch Control function).....59, 84

E

- Easy Search.....55, 85
- Editing Messages.....71
- Erasing Messages.....71
- Error Messages120
- External Microphone.....49, 89

F

- Folder27, 54, 97, 99

H

- HOLD.....25, 78

I

Index to Parts and Controls

Display window.....	10
Front.....	8
Rear.....	9

L

LCF function.....	41, 83
LPCM 22/16.....	17, 30, 32, 82
LPCM 44/16.....	17, 30, 32, 82
LPEC LP.....	17, 30, 32, 82
LPEC SP.....	17, 30, 32, 82
LPEC ST.....	17, 30, 32, 82
LPEC STHQ.....	17, 30, 32, 82
LPEC STLP.....	17, 30, 32, 82

M

Maintenance.....	128
Manual Recording Mode.....	35
Menu	
ADD/OVER WRITE.....	80, 86
ALARM.....	81, 87
BACKLIGHT.....	81, 91
BEEP.....	81, 90
DATE & TIME.....	81, 89
DETAIL MENU.....	81, 88

DISPLAY.....	80, 84
DPC.....	80, 84
EASY SEARCH.....	80, 85
EFFECT.....	80, 85
ERASE ALL.....	80, 86
ERASE BOOKMARK.....	80, 87
FORMAT.....	81, 90
LCF (LOW CUT).....	80, 83
LED.....	81, 91
LIMITER.....	23, 88
Making Settings.....	79
MENU LANGUAGE.....	81, 91
Menu settings.....	80
MOVE.....	80, 87
PLAY MODE.....	80, 86
PRE REC.....	81, 88
REC LEVEL.....	80, 83
REC MODE.....	80, 82
SELECT INPUT.....	81, 89
SYNC REC.....	81, 88
TIME DISPLAY.....	81, 89
USB CHARGE.....	81, 92
V-UP.....	80, 85
VOR.....	80, 84

Message number.....	10
Monitoring the recording.....	29
Moving a Message.....	73, 87
MP3 128k.....	17, 30, 32, 82
MP3 192k.....	17, 30, 32, 82
MP3 48k.....	17, 30, 32, 82
MP3 file.....	30, 97, 129

N

Noise.....	128
------------	-----

P

Pause recording.....	29, 43, 52
Playback mode.....	57, 86
Playing Back Messages.....	54
Precautions.....	127
Preparing a Power Source.....	14
Priority Mark(s).....	77

R

Rechargeable battery.....	7, 14, 16
Recording from a telephone.....	50
Recording from other equipment.....	50
Recording level.....	33, 83
Recording Messages.....	27
Recording mode.....	30, 82
Recording time.....	32

Recording with an external microphone.....	49
Recording with other equipment.....	66
Record standby mode.....	35
Reinforcing the bass sound.....	60, 85
Remaining recording time.....	12
Remaining time.....	84
Repeat play of a message.....	57, 58, 86
Review.....	55

S

Setting the clock.....	19
Setting the language.....	21, 91
Software.....	101
Specifications.....	129
Stand.....	7, 23
Synchronized recording.....	51, 88
System Limitations.....	123

T

Transferring Files.....	108
Troubleshooting.....	110
Digital Voice Editor.....	117
IC recorder.....	110
Turning the IC Recorder On or Off.....	25

U

USB AC adaptor	125
USB charging.....	92
USB mass storage device.....	109

V

Voice up.....	63, 85
VOR function	42, 80, 84

W

WMA file	97, 129
----------------	---------

Trademarks

- Microsoft, Windows, Windows Vista, Windows Media, Outlook, DirectX and logos are trademarks or registered trademarks of Microsoft Corporation in the United States and/or other countries.
- Apple and Macintosh are trademarks of Apple Inc., registered in the USA and other countries.
- Pentium is a registered trademark of Intel Corporation.
- Nuance, the Nuance logo, Dragon NaturallySpeaking, and RealSpeak are trademarks and/or registered trademarks of Nuance Communications, Inc., and/or its affiliates in the United States and/or other countries.
© 2007 - 2008 Nuance Communications, Inc. All rights reserved.
- MPEG Layer-3 audio coding technology and patents licensed from Fraunhofer IIS and Thomson.
- "Memory Stick" and  are trademarks of Sony Corporation.
- "LPECC" and  are registered trademarks of Sony Corporation.
- US and foreign patents licensed from Dolby Laboratories.

All other trademarks and registered trademarks are trademarks or registered trademarks of their respective holders. Furthermore, "™" and "®" are not mentioned in each case in this manual.

The "Digital Voice Editor" uses software modules as shown below:
Microsoft DirectX Runtime 9.0c
©2004 Microsoft Corporation. All Rights Reserved.



This product is protected by certain intellectual property rights of Microsoft Corporation. Use or distribution of such technology outside of this product is prohibited without a license from Microsoft or an authorized Microsoft subsidiary.

<http://www.sony.net/>